



**4K HDR**

**HDCP 2.2**



# DS-MSC14-4K22

**1 to 4 Multi-screen Controller with 4K HDR Input Support  
and HDCP.2.2**

**OPERATION MANUAL**



## **DISCLAIMERS**

The information in this manual has been carefully checked and is believed to be accurate. CYP (UK) Ltd assumes no responsibility for any infringements of patents or other rights of third parties which may result from its use.

CYP (UK) Ltd assumes no responsibility for any inaccuracies that may be contained in this document. CYP (UK) Ltd also makes no commitment to update or to keep current the information contained in this document.

CYP (UK) Ltd reserves the right to make improvements to this document and/or product at any time and without notice.

## **COPYRIGHT NOTICE**

No part of this document may be reproduced, transmitted, transcribed, stored in a retrieval system, or any of its part translated into any language or computer file, in any form or by any means—electronic, mechanical, magnetic, optical, chemical, manual, or otherwise—without express written permission and consent from CYP (UK) Ltd.

© Copyright 2020 by CYP (UK) Ltd.

All Rights Reserved.

Version 1.1

## **TRADEMARK ACKNOWLEDGMENTS**

All products or service names mentioned in this document may be trademarks of the companies with which they are associated.

## SAFETY PRECAUTIONS

Please read all instructions before attempting to unpack, install or operate this equipment and before connecting the power supply.

Please keep the following in mind as you unpack and install this equipment:

- Always follow basic safety precautions to reduce the risk of fire, electrical shock and injury to persons.
- To prevent fire or shock hazard, do not expose the unit to rain, moisture or install this product near water.
- Never spill liquid of any kind on or into this product.
- Never push an object of any kind into this product through any openings or empty slots in the unit, as you may damage parts inside the unit.
- Do not attach the power supply cabling to building surfaces.
- Use only the supplied power supply unit (PSU). Do not use the PSU if it is damaged.
- Do not allow anything to rest on the power cabling or allow any weight to be placed upon it or any person walk on it.
- To protect the unit from overheating, do not block any vents or openings in the unit housing that provide ventilation and allow for sufficient space for air to circulate around the unit.

## REVISION HISTORY

VERSION NO.	DATE	SUMMARY OF CHANGE
v1.00	30/04/2020	First release
v1.01	12/06/2020	Updated Cover Image

# CONTENTS

<b>1. Introduction</b> .....	<b>6</b>
<b>2. Applications</b> .....	<b>6</b>
<b>3. Package Contents</b> .....	<b>6</b>
<b>4. System Requirements</b> .....	<b>7</b>
<b>5. Features</b> .....	<b>7</b>
<b>6. Operation Controls and Functions</b> .....	<b>8</b>
6.1 Front Panel .....	8
6.2 Rear Panel.....	9
6.3 RS-232 Pinout and Defaults .....	10
6.4 Video Wall App.....	11
6.5 Telnet Control.....	21
6.6 Serial and Telnet Commands.....	22
<b>7. Connection Diagram</b> .....	<b>28</b>
<b>8. Specifications</b> .....	<b>29</b>
8.1 Technical Specifications .....	29
8.2 Video Specifications.....	30
8.3 Audio Specifications.....	32
8.4 Cable Specifications .....	33
<b>9. Acronyms</b> .....	<b>34</b>

## 1. INTRODUCTION

This 4K/UHD 4 by 4 HDMI Video Wall Processor can take any standard 4K (or lower) HDMI source and generate a high quality 2x2 video wall with bezel compensation and full audio bypass. The HDMI input supports 4K UHD HDMI video, up to and including 4K@60Hz (4:4:4, 8-bit) as well as 10/12-bit sources with HDR. Each of the unit's 4 outputs generates 1080p@60Hz video which allows for the creation of a full resolution 4K video wall from 4K sources.

Built in advanced EDID management options including Internal, External, and User configurations, as well as advanced HDCP management, allows this video wall processor to handle almost any source situation. Additionally, multiple video wall processors can be used together to generate video walls with configurations as large as 8x8. A dedicated PC application allows the user to fully customize the video wall and associated features. Additional control interfaces are also available including RS-232, and Telnet.

## 2. APPLICATIONS

- /// Public Advertisements
- /// Digital Presentations
- /// Retail Displays
- /// Stock Market Displays

## 3. PACKAGE CONTENTS

- /// 1x UHD+ 1 by 4 HDMI Video Wall Processor
- /// 1x 24V/1.25A DC Power Adapter
- /// 1x Shockproof Feet (Set of 4)
- /// 1x Operation Manual

## 4. SYSTEM REQUIREMENTS

- /// HDMI source equipment such as a media player, video game console or set-top box.
- /// HDMI receiving equipment such as HDTVs, monitors or audio amplifiers.

## 5. FEATURES

- /// HDMI 2.0 and DVI 1.0 compliant
- /// HDCP 1.x and 2.2 compliant
- /// 1 HDMI input
- /// 4 HDMI outputs
- /// HDMI input supports resolutions up to 4K UHD<sup>+</sup> (18Gbps, 4096×2160@60Hz 4:4:4, 8-bit)
- /// HDMI output resolution is fixed at 1080p@60Hz
- /// Supports 10-bit and 12-bit HDR (High Dynamic Range) input with automatic conversion to standard range 8-bit prior to output
- /// Supports pass-through of many audio formats including LPCM (up to 8 channels), Bitstream and HD Bitstream
- /// A single unit supports 2×2 video wall generation, multiple units can be user together to generate video walls up to 8×8
- /// Supports horizontal and vertical bezel compensation
- /// Comprehensive EDID and HDCP management
- /// Controllable via dedicated PC app, Telnet, and RS-232

## 6. OPERATION CONTROLS AND FUNCTIONS

### 6.1 Front Panel

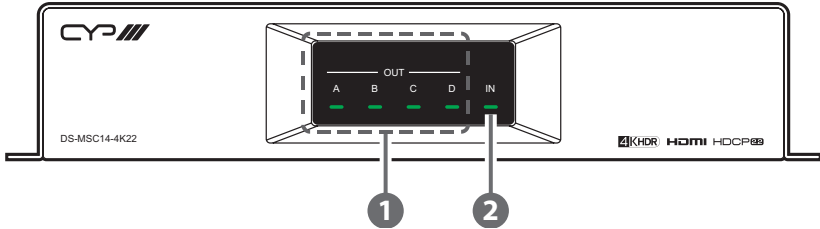

- 1 OUT A~D LEDs:** These LEDs will illuminate to indicate when a valid sink has been detected on the associated output port. When no sink is detected the LED will remain off.
- 2 IN LED:** This LED will illuminate green to indicate that a live source has been detected on the input port. When no source is detected the LED will illuminate amber.



## 6.2 Rear Panel

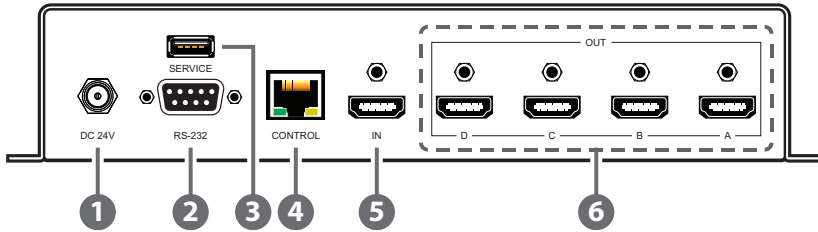

- 1 DC 24V Port:** Plug the 24V DC power adapter into this port and connect it to an AC wall outlet for power.
- 2 RS-232 Port:** Connect directly to a PC, laptop, or other serial control device to send RS-232 commands to control the unit directly or via PC App.
- 3 SERVICE Port:** This port is reserved for firmware update use only.
- 4 CONTROL Port:** Connect directly, or through a network switch, to your PC/laptop to control the unit via Telnet/PC App.
- 5 HDMI IN Port:** Connect to HDMI source equipment such as a media player, game console or set-top box.
- 6 HDMI OUT A~D Ports:** Connect to HDMI TVs, monitors, or amplifiers for digital video and audio output.

### 6.3 RS-232 Pinout and Defaults

Serial Port Default Settings	
<b>Baud Rate</b>	19200
<b>Data Bits</b>	8
<b>Parity Bits</b>	None
<b>Stop Bits</b>	1
<b>Flow Control</b>	None

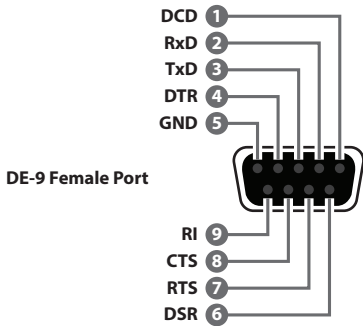

## 6.4 Video Wall App

The PC based Video Wall App provides complete control over one or more Video Wall Processors via Ethernet or RS-232. This software can scan the local network, as well as any RS-232 connections on the PC, for controllable units to add to the current video wall grouping. Commonly used video wall configurations can be quickly selected or the configuration can be manually set up.

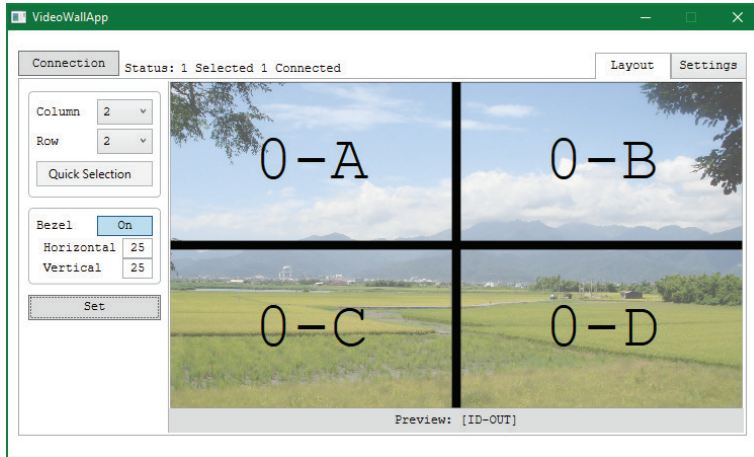

In addition to video wall setup this software can also be used to configure the network, EDID and HDCP settings, if needed.

### 6.4.1 Software Operation

Please obtain the “Video Wall App” software from your authorized dealer and save it in a directory where you can easily find it.

Ensure that all the units you wish to control have been powered on and that they are all connected to the same network as your laptop/ PC. Start the software by double clicking on the \*.exe file to start the Video Wall App software.

By default, when the software starts, the layout will be empty and no units will be connected. To add one or more physical units (with 4 displays per unit) to the video wall layout, click on the “Connection” button to open the “Connection Window”.

*Note: This software is only compatible with Windows 7 or later PCs.*

## 6.4.2 Connection Window

By clicking on the “Connection” button at the top-left corner of the main window the “Connection Window” will open up and list all Video Wall Processors that are currently detected on the local network as well as listing all available RS-232 ports on the PC. Each detected unit can then be added to the current video wall layout and assigned a unique ID number.

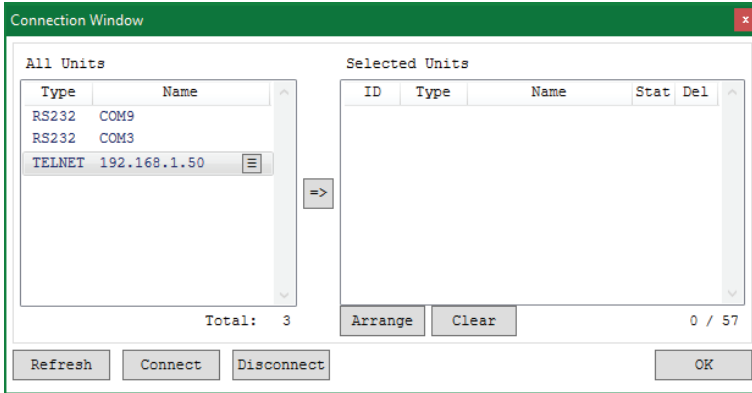

Once all units have been added to the list, click the “Connect” button to connect to all of the units. If desired, the order of the units, if more than one is required for the video wall, may also be changed here. Once everything is configured, click “OK” to close the window and return to the Layout tab.

*Note: Units connected via RS-232 can't be directly detected, so all available serial ports will be listed, even if they do not currently have a connected unit.*

- All Units List:** All detected units on the local network as well as all available local serial ports are listed here. All detected units are identified by their IP address. Selecting a Unit (or serial port) and then clicking the right arrow button (=>) will place them in the Selected Units window in the order they are added. The Ethernet details of each detected unit may also be changed by clicking on the associated details icon (☰).

*Note: A unit's Ethernet settings cannot be changed if the software is actively “Connected” to it. To make changes, please press the “Disconnect” button first.*

- **Refresh Button:** Click this button to detect any additional units that were added to the network after the window was opened.

- 2) **Selected Units List:** All selected units will appear here with an ID number indicating their order to be added to the layout. To remove an individual unit from the list, click the “x” in the unit’s “Del” column.

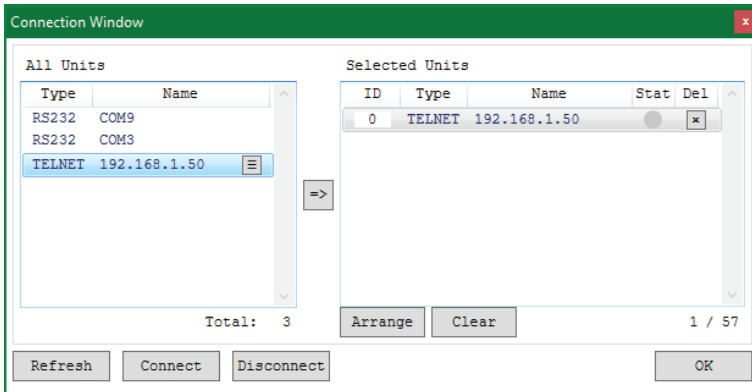

- **Arrange Button:** To re-order the units in the list, type new ID numbers next to each unit and click on this button.  
*Note: ID numbers can only be changed while a unit is disconnected.*
- **Clear Button:** Click this button to remove all units from the Selected Units list.

- 3) **Connect Button:** Clicking this button will activate the software's connection to all units in the Selected Units list, allowing control and configuration of those units. The "Stat" column will show a green circle next to each successfully connected unit.

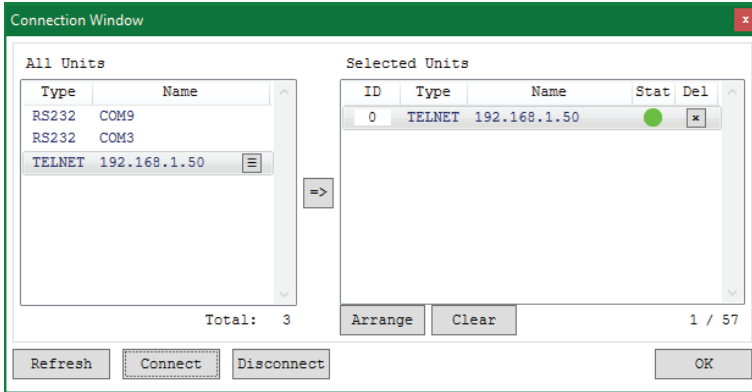

- 4) **Disconnect Button:** Click this button to disconnect the software from all units. The "Stat" column will show a gray circle next to disconnected units.

### 6.4.3 Layout Tab

The Layout Tab provides control over the dimensions of the video wall as well as how much bezel compensation to apply. The video wall's general appearance, and the position of the 4 displays connected to each unit, is represented by the large window to the right. Each display is labeled with the unit's ID# and output letter. The number of currently connected units is displayed at the top of the tab.

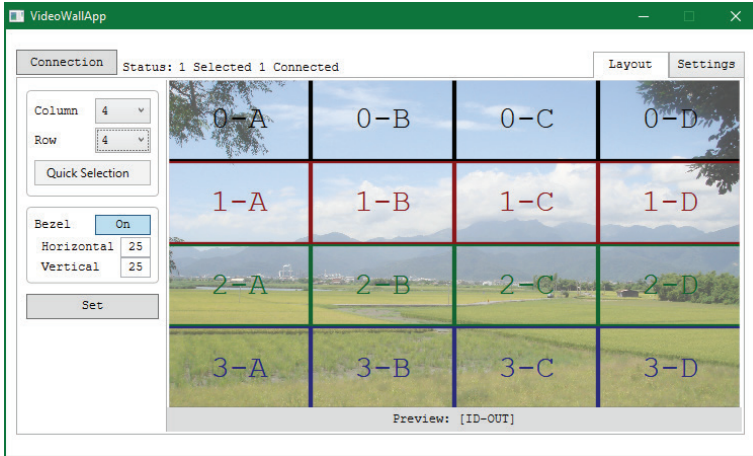

- 1) **Video Wall Geometry:** This section sets the number of displays used in the video wall. Up to a maximum of 64 displays can be supported (8x8 video wall).

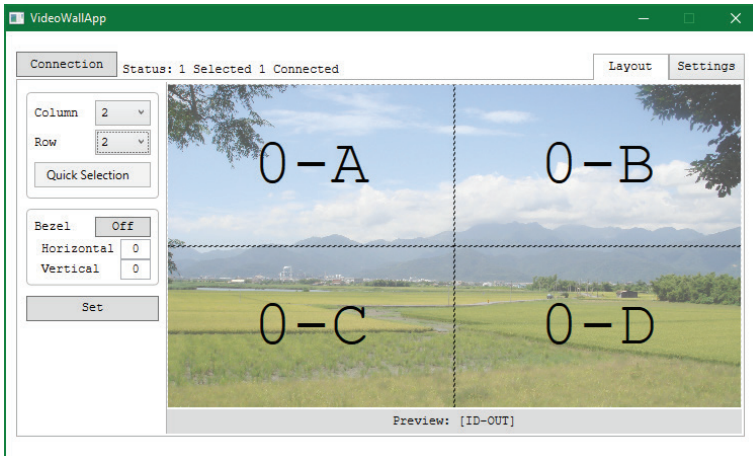

- **Column:** Sets the number of displays in the video wall, measured horizontally. (Maximum is 8 displays)
- **Row:** Sets the number of displays in the video wall, measured vertically. (Maximum is 8 displays)
- **Quick Selection:** Provides a quick way to select common video

wall dimensions. Options are: 1×1, 1×2, 1×3, 1×4, 2×2, 3×3

- 2) **Bezel Settings:** Configures the bezel size to compensate for around all displays.

*Note: Bezel settings assume that the top/bottom and left/right bezel pairs are uniform in size and all displays in the video wall share the same dimensions.*

- **Bezel Enable:** Click this button to enable or disable the use of bezel compensation.
- **Horizontal:** Set the size, in pixels, of the vertical bezel compensation. (Maximum value is 50)
- **Vertical:** Set the size, in pixels, of the vertical bezel compensation. (Maximum value is 50)

- 3) **Set Button:** After fully defining all components of the video wall, or after making changes to an existing layout, click this button to confirm the new settings and transmit them to the connected units.

#### 6.4.4 Settings Tab

The basic configuration and settings for each connected unit can be set here by selecting the unit to configure from the “ID-NAME” list on the left side. To exit the setting configuration tabs and return to the layout mode, click on the “Layout” button in the upper-right section of the window.

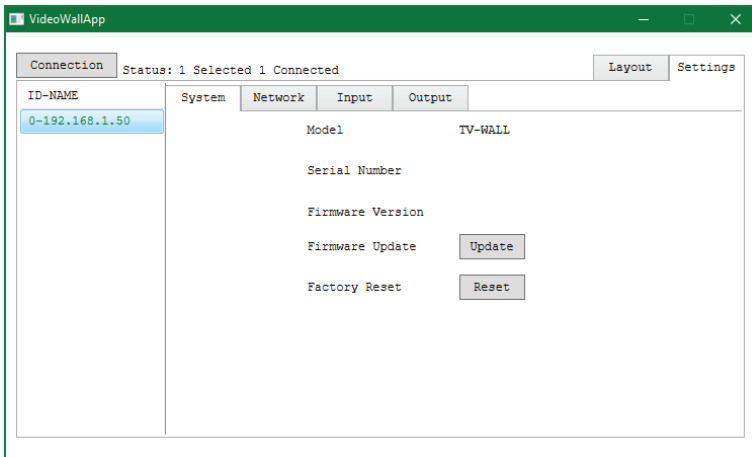



1) **System Menu:** This window provides information about the selected unit's serial number, and firmware version as well as providing a way to update the firmware or reboot the unit.

- **Serial Number:** Displays the unit's serial number.
- **Firmware Version:** Displays the unit's current firmware version.
- **Firmware Update:** Provides a way to update the unit's firmware. Insert a USB thumb drive, with a valid firmware file (\*.bin format) in the root directory, into the unit's USB service port then click the "Update FW" button. After the update is complete the unit will automatically reboot.
- **Factory Reset:** Selecting this will reset the unit's settings back to their factory defaults.

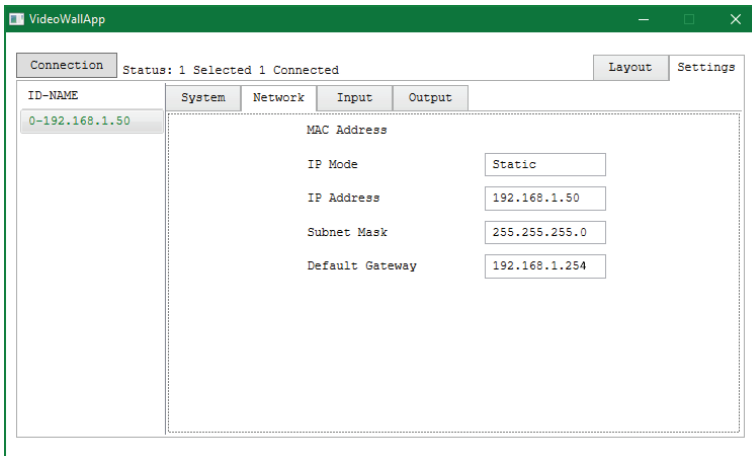

2) **Network Menu:** This window displays the unit's MAC address and current network configuration.

*Note: These settings can only be changed within the Connection Window. See section 6.4.2.*

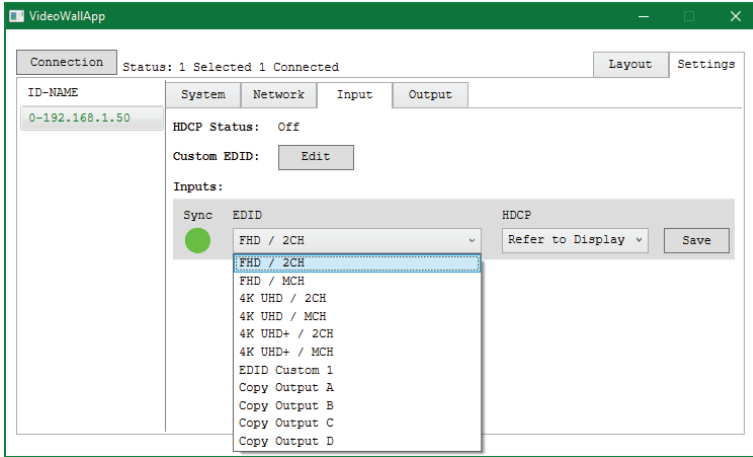

**3) Input Menu:** This window provides control over functions of the unit's HDMI input including the handling of EDID and HDCP.

- **HDCP Status:** Displays the current HDCP status of the unit's HDMI input.
- **Custom EDID:** Click this button to open the Custom EDID Settings window and upload or rename the custom EDID. To rename the EDID, type a new name in the space provided and click "Save". To upload a custom User EDID, insert a USB thumb drive, with a valid EDID file named "USEREDID.BIN" in the root directory, into the unit's USB service port then click the "Upload" button.

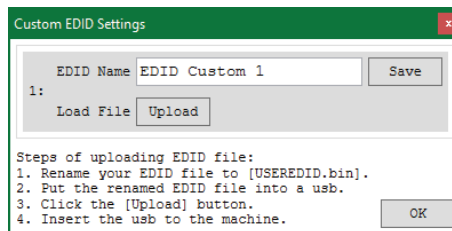

*Note: After the firmware upload is complete the unit will automatically reboot.*

- **Sync Indicator:** When a live source is detected, this will be green, when no source is detected it will be grey.
- **EDID Selection:** Select the preferred EDID for the unit to use from the dropdown menu. This unit provides the option of six standard EDIDs, four sink sourced EDIDs and one user uploaded EDID.

*Note: In most cases, assigning a new EDID to an input will cause the affected input to briefly blink out while the source adapts to the new information.*

This unit provides the following 6 default EDIDs:

Unit's Default EDIDs		
<b>FHD/2CH</b>	1920×1080p@60Hz (4.95Gbps) & 8-bit color,	LPCM 2.0
<b>FHD/MCH</b>	1920×1080p@60Hz (4.95Gbps) & 8-bit color,	LPCM 7.1 & Bitstream
<b>UHD/2CH</b>	3840×2160p@30Hz (10.2Gbps) & Deep Color (8/10/12-bit),	LPCM 2.0
<b>UHD/MCH</b>	3840×2160p@30Hz (10.2Gbps) & Deep Color (8/10/12-bit),	LPCM 7.1 & Bitstream
<b>4K UHD+/2CH</b>	3840×2160p@60Hz (18Gbps) & Deep Color (8/10/12-bit),	LPCM 2.0
<b>4K UHD+/MCH</b>	3840×2160p@60Hz (18Gbps) & Deep Color (8/10/12-bit),	LPCM 7.1 & Bitstream

*Note: In some rare cases it is possible for custom or external EDIDs to cause compatibility issues with certain sources. If this happens, it is recommended to switch to one of the 6 default EDIDs for maximum compatibility.*

- **HDCP Behavior:** Use the dropdown to select the HDCP behavior of the unit's HDMI input.

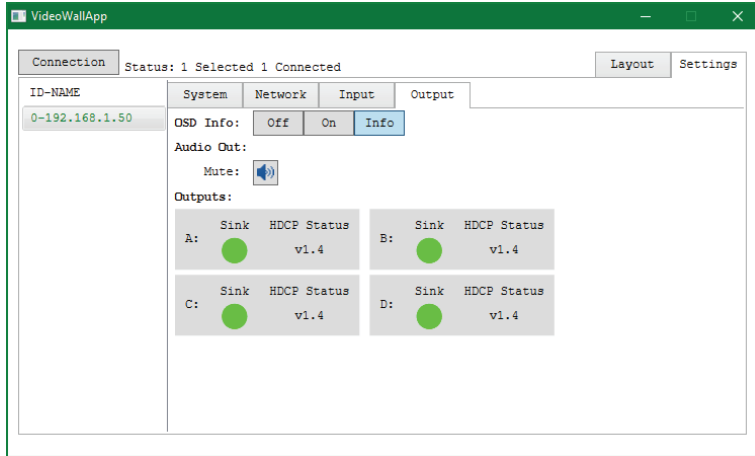

**4) Output Menu:** This window provides control over features relating to the unit’s HDMI outputs including the OSD information display, audio output and sync status.

*Note: These settings affect all 4 outputs.*

- **OSD Info:** Select the behavior of the informational OSD. Selecting “Off” disables it completely, selecting “On” will always display the OSD, and selecting “Info” will only show the OSD for a few seconds after a source or sync change.
- **Audio Out:** Click the speaker icon (  ) to enable or disable muting the audio output.
- **Output Status:** Displays the current connection and HDCP status of all 4 of the unit’s outputs.

## 6.5 Telnet Control

Before attempting to use Telnet control, please ensure that both the unit and the PC are connected to the same active networks.

To Access the Command Line Interface (CLI)	
Windows 7	Click <b>Start</b> , type “cmd” in the search field, and press <b>Enter</b> .
Windows XP	Click <b>Start &gt; Run</b> , type “cmd”, and press <b>Enter</b> .
Mac OS X	Click <b>Go &gt; Applications &gt; Utilities &gt; Terminal</b> .

Once in the Command Line Interface (CLI) type “**telnet**” followed by the IP address of the unit (and the port number if it is non-standard) and then hit “**Enter**”. This will connect us to the unit we wish to control.

```
Microsoft Windows [Version 6.1.7601]
Copyright (c) 2009 Microsoft Corporation. All rights reserved.

C:\Users\Administrator>telnet 192.168.1.50 23
```

*Note 1: If the IP address is changed then the IP address required for Telnet access will also change accordingly.*

*Note 2: The default IP address is 192.168.1.50.*

## 6.6 Serial and Telnet Commands

COMMAND
Description and Parameters
<p><b>help</b>↵</p> <p>Show the full command list.</p>
<p><b>help N1</b>↵</p> <p>Show details about the specified command.</p> <p><b>N1</b> = {Command name}</p>
<p><b>get model name</b>↵</p> <p>Show the unit's model name.</p>
<p><b>get fw ver</b>↵</p> <p>Show the unit's current firmware version.</p>
<p><b>set update mcu</b>↵</p> <p>Initiate firmware update via the USB port.</p>
<p><b>set factory default</b>↵</p> <p>Reset the unit to the factory defaults.</p>
<p><b>set ip mode N1</b>↵</p> <p>Set the IP address assignment mode.</p> <p>Available values for N1:</p> <p>0                            [Static IP mode]</p> <p>1                            [DHCP mode]</p>
<p><b>get ip mode</b>↵</p> <p>Show the current IP address assignment mode.</p>
<p><b>get ipconfig</b>↵</p> <p>Show the unit's current IP configuration information.</p>

COMMAND
Description and Parameters
<b>set ipaddr N1</b> ← Set the unit's static IP address. <b>N1</b> = X.X.X.X            [X = 0~255, IP address]
<b>get ipaddr</b> ← Show the unit's current IP address.
<b>set netmask N1</b> ← Set the unit's static netmask. <b>N1</b> = X.X.X.X            [X = 0~255, Netmask]
<b>get netmask</b> ← Show the unit's current netmask.
<b>set gateway N1</b> ← Set the unit's static gateway address. <b>N1</b> = X.X.X.X            [X = 0~255, Gateway address]
<b>get gateway</b> ← Show the unit's current gateway address.
<b>get in 1 sync status</b> ← Show the current sync state of the HDMI input. Available response values: 0                            [No sync] 1                            [Sync active]

COMMAND	
Description and Parameters	
<b>set in 1 edid N1</b> ←	
Set the EDID to use on the HDMI input.	
Available values for <b>N1</b> :	
1	[FHD/2CH]
2	[FHD/MCH]
3	[UHD/2CH]
4	[UHD/MCH]
5	[UHD+/2CH]
6	[UHD+/MCH]
7	[User EDID]
8	[Sink A]
9	[Sink B]
10	[Sink C]
11	[Sink D]
<b>get in 1 edid</b> ←	
Show the EDID currently being used on the HDMI input.	
<b>set edid 7 name N1</b> ←	
Set the name for the specified EDID.	
<b>N1</b> = {Name}	[32 characters maximum]
<i>Note: Only User EDIDs may be renamed.</i>	
<b>get edid 7 name</b> ←	
Show the name for the specified EDID.	
<b>set in 1 hdcp mode N1</b> ←	
Set the HDCP behavior of the HDMI input.	
Available values for <b>N1</b> :	
0	[Disable]
1	[Follow in]
2	[Follow out]



COMMAND
<b>Description and Parameters</b>
<b>get in 1 hdcp mode</b> ← Show the current HDCP behavior used by the HDMI input.
<b>get in hdcp status</b> ← Show the current HDCP status of the HDMI input. Available response values: 0 [Off] 1 [HDCP1.x] 2 [HDCP2.2]
<b>get out N1 hdcp status</b> ← Show the current HDCP status of the specified output. <b>N1</b> = A~D [Output port] Available response values: 0 [Off] 1 [HDCP1.x] 2 [HDCP2.2] 3 [HDCP1.x failed] 4 [HDCP2.2 failed]
<b>set audio out mute N1</b> ← Enable or disable muting the audio output. Available values for <b>N1</b> : OFF [Audio unmuted] ON [Audio muted]
<b>get audio out mute</b> ← Show the current audio output mute state.

COMMAND
Description and Parameters
<p><b>get out N1 sync status</b> ←</p> <p>Show the current sync state of the specified output.</p> <p><b>N1</b> = A~D                      [Output port]</p> <p>Available response values:</p> <p>0                                      [No sync]</p> <p>1                                      [Sync active]</p>
<p><b>set out osd info display N1</b> ←</p> <p>Enable or disable the info OSD for all outputs.</p> <p>Available values for <b>N1</b>:</p> <p>OFF                                      [OSD always off]</p> <p>ON                                        [OSD always on]</p> <p>INF                                        [Momentary display mode]</p>
<p><b>get out osd info display</b> ←</p> <p>Show the current info OSD state for all outputs.</p>
<p><b>set video wall layout N1 N2</b> ←</p> <p>Set the video wall's total horizontal and vertical display count.</p> <p><b>N1</b> = 1~8                              [Horizontal display total]</p> <p><b>N2</b> = 1~8                              [Vertical display total]</p>
<p><b>get video wall layout</b> ←</p> <p>Show the video wall's current total horizontal and vertical display count.</p>
<p><b>set video wall h bezel compensation N1</b> ←</p> <p>Set the video wall's horizontal bezel compensation value.</p> <p><b>N1</b> = 0~50                              [Horizontal bezel compensation value]</p>

COMMAND	
Description and Parameters	
<b>get video wall h bezel compensation</b> ↵	Show the video wall's current horizontal bezel compensation value.
<b>set video wall bezel mode N1</b> ↵	<p>Enable or disable bezel compensation mode for the video wall.</p> <p>Available values for <b>N1</b>:</p> <p>OFF [Disabled] ON [Enabled]</p>
<b>get video wall bezel mode</b> ↵	Show the current state of the video wall's bezel compensation mode.
<b>set video wall unit index N1</b> ↵	<p>Set the unit's video wall index number.</p> <p><b>N1</b> = 0~15 [Video wall index number]</p>
<b>get video wall unit index</b> ↵	Show the unit's current video wall index number.
<b>set user 1 edid data</b> ↵	Initiate uploading a new User EDID to the unit via the USB port.

*Note: Commands will not be executed unless followed by a carriage return. Commands are not case-sensitive.*

# 7. CONNECTION DIAGRAM

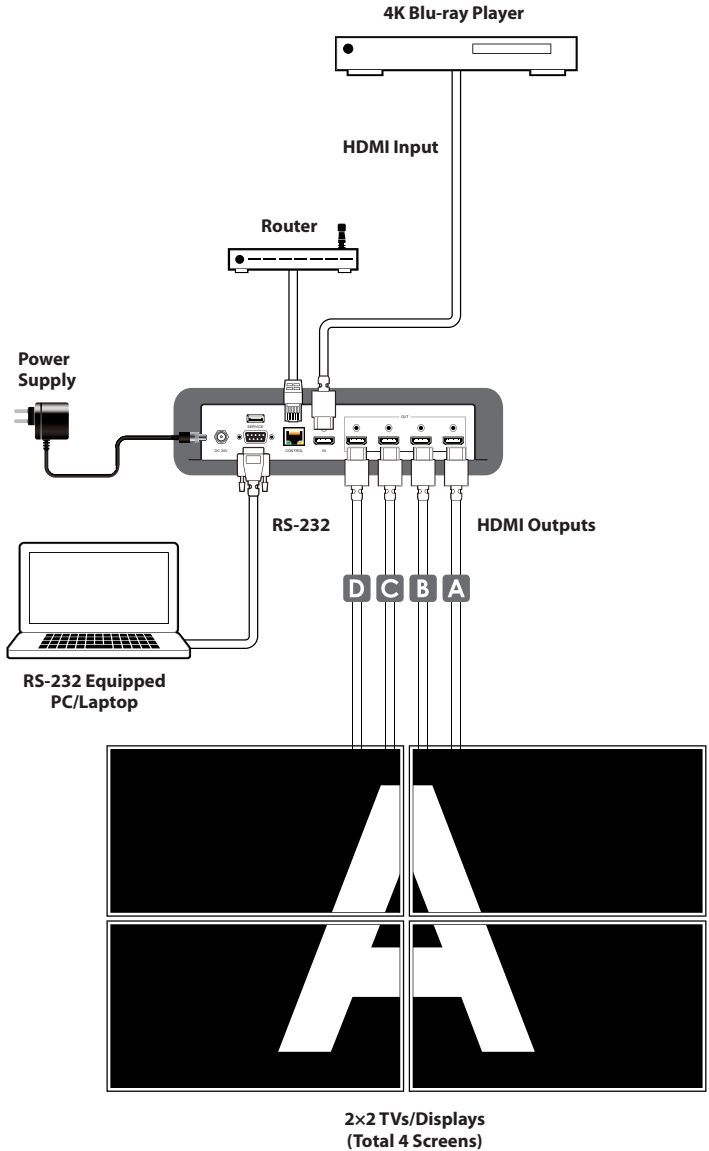

## 8. SPECIFICATIONS

### 8.1 Technical Specifications

<b>HDMI Bandwidth</b>	18Gbps
<b>Input Port</b>	1×HDMI (Type-A)
<b>Output Ports</b>	4×HDMI (Type-A)
<b>Control Ports</b>	1×RS-232 (DE-9) 1×Control (RJ-45)
<b>Service Port</b>	1×USB 2.0 (Type A)
<b>Baud Rate</b>	19200
<b>Power Supply</b>	24V/1.25A DC (US/EU standards, CE/FCC/UL certified)
<b>ESD Protection (HBM)</b>	±8kV (Air Discharge) ±4kV (Contact Discharge)
<b>Dimensions (W×H×D)</b>	231.5mm×44mm×167mm [Case Only] 231.5mm×44mm×174mm [All Inclusive]
<b>Weight</b>	652g
<b>Chassis Material</b>	Metal (Steel)
<b>Chassis Color</b>	Black
<b>Operating Temperature</b>	0°C – 40°C/32°F – 104°F
<b>Storage Temperature</b>	-20°C – 60°C/-4°F – 140°F
<b>Relative Humidity</b>	20 – 90% RH (Non-condensing)
<b>Power Consumption</b>	9.5W

## 8.2 Video Specifications

Supported Resolutions (Hz)	Input	Output
	HDMI	HDMI
720×400p@70/85	✓	×
640×480p@60/72/75/85	✓	×
720×480i@60	×	×
720×480p@60	✓	×
720×576i@50	×	×
720×576p@50	✓	×
800×600p@56/60/72/75/85	✓	×
848×480p@60	✓	×
1024×768p@60/70/75/85	✓	×
1152×864p@75	✓	×
1280×720p@50/60	✓	×
1280×768p@60/75/85	✓	×
1280×800p@60/75/85	✓	×
1280×960p@60/85	✓	×
1280×1024p@60/75/85	✓	×
1360×768p@60	✓	×
1366×768p@60	✓	×
1400×1050p@60	✓	×
1440×900p@60/75	✓	×
1600×900p@60RB	✓	×
1600×1200p@60	✓	×
1680×1050p@60	✓	×
1920×1080i@50/60	×	×

Supported Resolutions (Hz)	Input	Output
	HDMI	HDMI
1920×1080p@24/25/30	✓	×
1920×1080p@50/60	✓	60
1920×1200p@60RB	✓	×
2560×1440p@60RB	✓	×
2560×1600p@60RB	✓	×
2048×1080p@24/25/30	✓	×
2048×1080p@50/60	✓	×
3840×2160p@24/25/30	✓	×
3840×2160p@50/60 (4:2:0)	✓	×
3840×2160p@24, HDR10	×	×
3840×2160p@50/60 (4:2:0), HDR10	×	×
3840×2160p@50/60	✓	×
4096×2160p@24/25/30	✓	×
4096×2160p@50/60 (4:2:0)	✓	×
4096×2160p@24, HDR10	×	×
4096×2160p@50/60 (4:2:0), HDR10	×	×
4096×2160p@50/60	✓	×

## 8.3 Audio Specifications

### 8.3.1 Digital Audio

HDMI Input / Output	
LPCM	
Max Channels	8 Channels
Sampling Rate (kHz)	32, 44.1, 48, 88.2, 96, 176.4, 192
Bitstream	
Supported Formats	Standard & High-Definition

## 8.4 Cable Specifications

Cable Length	1080p		4K30	4K60
	8-bit	12-bit	(4:4:4) 8-bit	(4:4:4) 8-bit
High Speed HDMI Cable				
HDMI Input	15m	10m	5m	3m
HDMI Output	15m	10m	x	

### Bandwidth Category Examples:

#### 1080p (FHD Video)

- Up to 1080p@60Hz, 12-bit color
- Data rates lower than 5.3Gbps or below 225MHz TMDS clock

#### 4K30 (UHD Video)

- 4K@24/25/30Hz & 4K@50/60Hz (4:2:0), 8-bit color
- Data rates higher than 5.3Gbps or above 225MHz TMDS clock but below 10.2Gbps

#### 4K60 (UHD<sup>+</sup> Video)

- 4K@50/60Hz (4:4:4, 8-bit)
- 4K@50/60Hz (4:2:0, 10-bit HDR)
- Data rates higher than 10.2Gbps



## 9. ACRONYMS

ACRONYM	COMPLETE TERM
<b>CEC</b>	Consumer Electronics Control
<b>CLI</b>	Command-Line Interface
<b>DHCP</b>	Dynamic Host Configuration Protocol
<b>DVI</b>	Digital Visual Interface
<b>EDID</b>	Extended Display Identification Data
<b>Gbps</b>	Gigabits per second
<b>GUI</b>	Graphical User Interface
<b>HDCP</b>	High-bandwidth Digital Content Protection
<b>HDMI</b>	High-Definition Multimedia Interface
<b>HDR</b>	High Dynamic Range
<b>IP</b>	Internet Protocol
<b>kHz</b>	Kilohertz
<b>LAN</b>	Local Area Network
<b>LED</b>	Light-Emitting Diode
<b>LPCM</b>	Linear Pulse-Code Modulation
<b>MAC</b>	Media Access Control
<b>MHz</b>	Megahertz
<b>OSD</b>	On-Screen Display
<b>TCP</b>	Transmission Control Protocol
<b>TMDS</b>	Transition-Minimized Differential Signaling
<b>UHD</b>	Ultra-High-Definition (10.2Gbps)
<b>UHD+</b>	Ultra-High-Definition Plus (18Gbps)
<b>USB</b>	Universal Serial Bus
<b>WUXGA (RB)</b>	Widescreen Ultra Extended Graphics Array (Reduced Blanking)



---

CYP (UK) Ltd., Unit 7, Shepperton Business Park, Govett Avenue, Shepperton,  
Middlesex, TW17 8BA

Tel: +44 (0) 20 3137 9180 | Fax: +44 (0) 20 3137 6279

Email: [sales@cypeurope.com](mailto:sales@cypeurope.com)

[www.cypeurope.com](http://www.cypeurope.com)

v1.01