



PU-515PL-KIT

HDBaseT™ LITE Extender Kit with PoE & 2-way IR (up to 60m)

OPERATION MANUAL

DISCLAIMERS

The information in this manual has been carefully checked and is believed to be accurate. CYP (UK) Ltd assumes no responsibility for any infringements of patents or other rights of third parties which may result from its use.

CYP (UK) Ltd assumes no responsibility for any inaccuracies that may be contained in this document. CYP (UK) Ltd also makes no commitment to update or to keep current the information contained in this document.

CYP (UK) Ltd reserves the right to make improvements to this document and/or product at any time and without notice.

COPYRIGHT NOTICE

No part of this document may be reproduced, transmitted, transcribed, stored in a retrieval system, or any of its part translated into any language or computer file, in any form or by any means—electronic, mechanical, magnetic, optical, chemical, manual, or otherwise—without express written permission and consent from CYP (UK) Ltd.

© Copyright 2011 by CYP (UK) Ltd.

All Rights Reserved.

Version 1.1 August 2011

TRADEMARK ACKNOWLEDGMENTS

All products or service names mentioned in this document may be trademarks of the companies with which they are associated

SAFETY PRECAUTIONS

Please read all instructions before attempting to unpack, install or operate this equipment and before connecting the power supply.

Please keep the following in mind as you unpack and install this equipment:

- Always follow basic safety precautions to reduce the risk of fire, electrical shock and injury to persons.
- To prevent fire or shock hazard, do not expose the unit to rain, moisture or install this product near water.
- Never spill liquid of any kind on or into this product.
- Never push an object of any kind into this product through any openings or empty slots in the unit, as you may damage parts inside the unit.
- Do not attach the power supply cabling to building surfaces.
- Use only the supplied power supply unit (PSU). Do not use the PSU if it is damaged.
- Do not allow anything to rest on the power cabling or allow any weight to be placed upon it or any person walk on it.
- To protect the unit from overheating, do not block any vents or openings in the unit housing that provide ventilation and allow for sufficient space for air to circulate around the unit.

REVISION HISTORY

VERSION NO.	DATE	SUMMARY OF CHANGE
v1.01	25/10/2013	First release





CONTENTS

1. Introduction	6
2. Applications	6
3. Package Contents	6
4. System Requirements	6
5. Features.....	7
6. Operation Controls and Functions	8
6.1 Transmitter Front and Rear Panels.....	8
6.2 Receiver Front and Rear Panels	9
6.3 D-Sub 9-Pin Definitions.....	10
6.4 IR Cable Pin Assignment	10
7. Connection Diagram	11
8. Specifications.....	13
9. Acronyms.....	14









1. INTRODUCTION

The PU-515PL-KIT allows uncompressed HDMI signals to be transmitted over a Single CAT5e/6/7 cable. This solution has the added features of RS-232 and 2-way IR control, and Power over Ethernet (PoE) functionality over the same CAT5e/6/7 cable. These combined HDMI and control signals can be transmitted up to lengths of 60 metres.

2. APPLICATIONS

-  Domestic HDMI installations
-  University lecturing systems
-  Retail showroom systems
-  Conference presentation and control

3. PACKAGE CONTENTS

-  1×HDMI over Single CAT5e/6/7 Transmitter with PoE
-  1×HDMI over Single CAT5e/6/7 Receiver with PoE
-  1×IR Blaster
-  1×IR Extender
-  1×3.5 mm Mini-jack to RS-232 Female Cable
-  1×3.5 mm Mini-jack to RS-232 Male Cable
-  24 V/1.25 A DC Power Adaptor
-  Operation Manual

4. SYSTEM REQUIREMENTS

HDMI source equipment such as a DVD or Blu-ray player and HDMI equipped display (TV or monitor). HDMI and CAT5e/5/7 connection cables.

5. FEATURES

- /// HDMI 1.4 with 3D, 4Kx2K support, HDCP and DVI compliant
- /// Supports HDMI 1.4 (including HDCP) over a single CAT5e/6/7 up to 60m
- /// Complies with HDBaseT™- Lite specifications
- /// Full HD resolution support (1080p@60Hz/36-bit), 3D over 60m, 4Kx2K over 40m and PC resolution support (VGA to WUXGA) over CAT5e/6 cable
- /// HDMI input up to 15m with 8-bit deep colour, or 10m with 12-bit deep colour
- /// Supports HDMI output up to 15m with 8/12-bit deep colour
- /// Supports two-way IR, RS-232 Control, and Power Over Ethernet (PoE)

Installation friendly

Note

1. *This system was tested with CAT-6E/23AWG cables, results may vary with cables of a different specification.*
2. *The PoE function is designed for powering compatible receiver units only—do not use with non-PoE receivers or receivers of another brand.*

6. OPERATION CONTROLS AND FUNCTIONS

6.1 Transmitter Front and Rear Panels

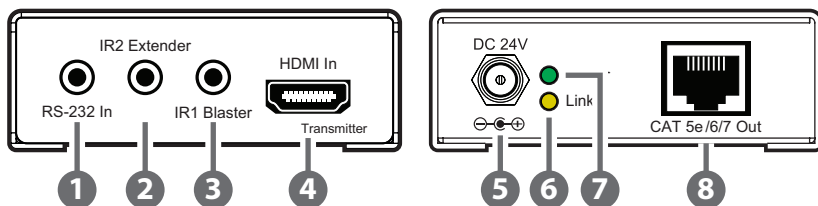

- 1 **RS232 In:** Connect to a PC/laptop or RS-232 control device (with supplied 3.5 mm mini-jack to D-sub 9-pin adaptor) for the transmission of RS-232 commands.
- 2 **IR2 Extender:** Connect an IR extender cable for IR signal reception. Ensure that remote control being used is within the direct line-of-sight of the IR extender.
- 3 **IR1 Blaster:** Connect an IR blaster cable for IR signal transmission. Place the IR blaster in direct line-of-sight of the equipment to be controlled.
- 4 **HDMI In:** Connect to the HDMI source equipment such as a DVD or Blu-ray player.
- 5 **DC 24V:** Connect the 24V DC power supply to the unit and plug the adaptor into an AC outlet.
- 6 **Link LED:** The yellow LED will illuminate when both the input and output CAT5e/6/7 signals are connected. The LED will blink when there is an error with the transmission signal.
- 7 **Power LED:** This green LED will illuminate when the device is connected to a power supply.
- 8 **CAT5e/6 Out:** Connect to the receiver unit with a single CAT5e/6/7 cable for transmission of all data signals.

6.2 Receiver Front and Rear Panels

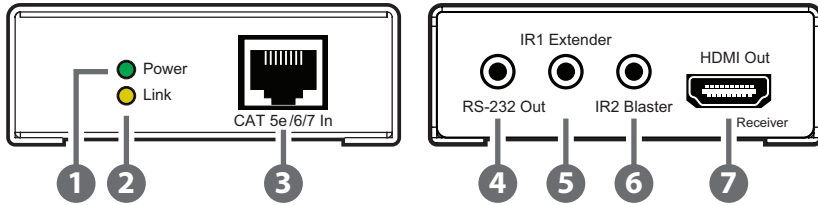

- 1 **RS232 Out:** Connect to the device that is to be controlled (with the supplied 3.5mm mini-jack to D-sub 9-pin adaptor) by RS-232 commands
- 2 **IR1 Extender:** Connect an IR extender cable for IR signal reception. Ensure that the remote being used is within the direct line-of-sight of the IR extender.
- 3 **IR2 Blaster:** Connect an IR blaster cable for IR signal transmission. Place the IR blaster in direct line of sight of the equipment to be controlled.
- 4 **HDMI Out:** Connect to a HDMI equipped TV/monitor for display of the HDMI input source signal.
- 5 **Link LED:** This yellow LED will illuminate when both the input and output CAT5e/6/7 signals are connected. The LED will blink when there is an error with the transmission signal.
- 6 **Power LED:** This green LED will illuminate when the device is connected to a power supply.
- 7 **CAT5e/6 In:** Connect to the transmitter unit with a Single CAT5e/6/7 cable for transmission of all data signals.

6.3 D-Sub 9-Pin Definitions

PIN	DEFINE TX/RX
1	N/C
2	TxD/RxD
3	RxD/TxD
4	N/C
5	GND
6	N/C
7	N/C
8	N/C
9	N/C

6.4 IR Cable Pin Assignment

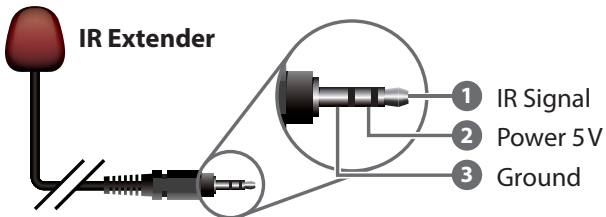
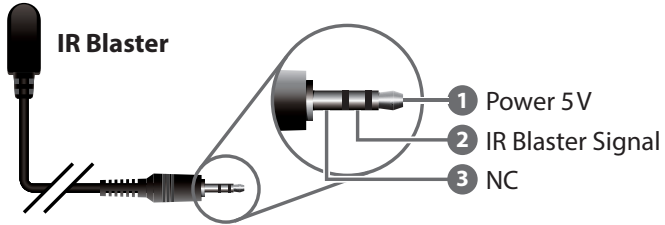

7. CONNECTION DIAGRAM

Example 1: Direct Connection

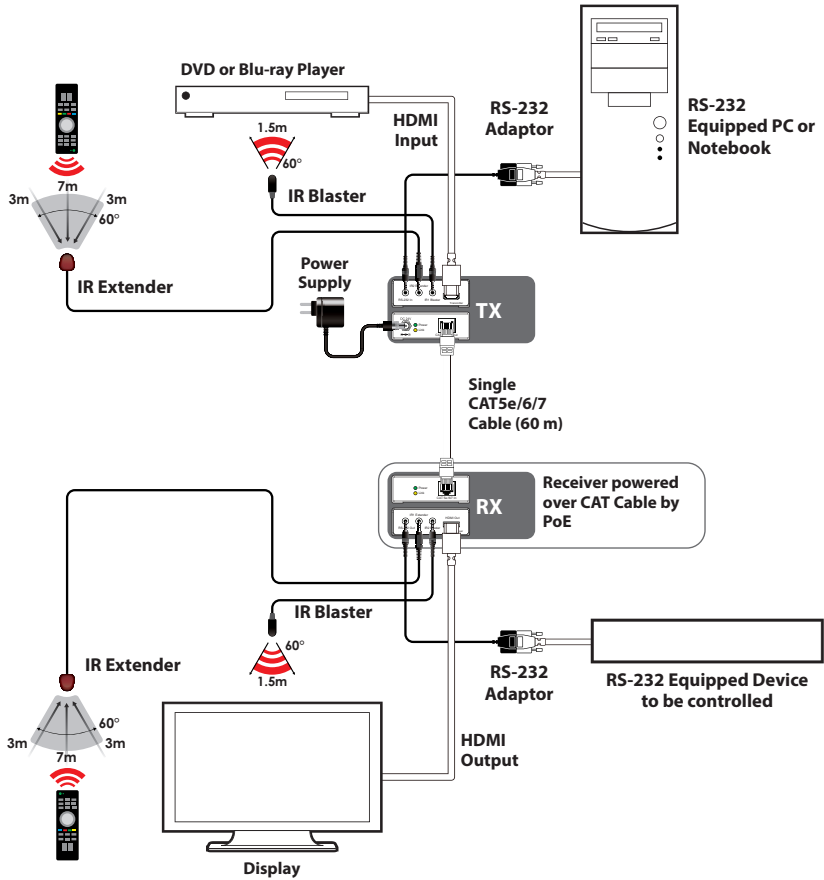

Example 2: Using a Repeater to Extend the Operating Distance

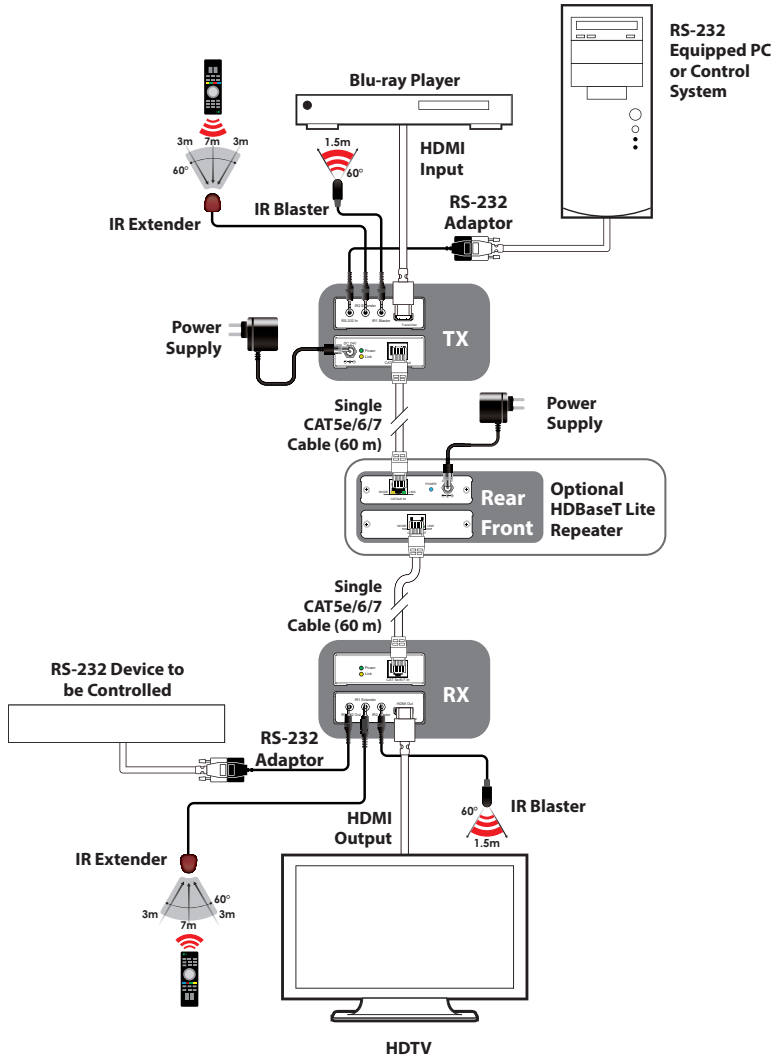

8. SPECIFICATIONS

Video Bandwidth	300 MHz/10.2 Gbps
Transmitter	
Input Ports	1×HDMI, 1×IR Extender, 1×RS-232
Output Ports	1×CAT5e/6/7, 1×IR Blaster
Receiver	
Input Ports	1×CAT5e/6/7, 1×IR Extender
Output Ports	1×HDMI, 1×IR Blaster, 1×RS-232
CAT5e/6/7 Cable Distance	Up to 60 meters
HDMI Input Cable Distance	15 meters/8-bit, 10 meters/12-bit
HDMI Output Cable Distance	15 meters/8-bit, 10 meters/12-bit
ESD Protection	Human Body Model: ±8kV (air-gap discharge) ±4kV (contact discharge)
Power Supply	24 V/1.25 A DC (US/EU standards, CE/ FCC/UL certified)
Dimensions	71 mm (W)×79 mm(D)×23 mm (H)/Each
Weight	120 g/TX, 126 g/RX
Chassis Material	Metal
Colour	Black
Operating Temperature	0 °C ~ 40 °C / 32 °F ~ 104 °F
Storage Temperature	-20 °C ~ 60 °C / -4 °F ~ 140 °F
Relative Humidity	20 ~ 90% RH (non-condensing)
Power Consumption	3 W/TX, 6 W/RX

CAT5e/6/7 Cable Specification:

LENGTH	BAND-WIDTH	DATA RATE	SUPPORTED VIDEO
UP TO 60M	UP TO 225MHZ	UP TO 5.3GBPS	HD VIDEO UP TO 1080P@60HZ/36-BIT, 3D (DATA RATE LOWER THAN 5.3 GBPS OR BANDWIDTH BELOW 225MHZ).
UP TO 35M	GREATER THAN 225MHZ	GREATER THAN 5.3GBPS	ULTRA HD VIDEO UP TO 4K×2K@30HZ.

9. ACRONYMS

ACRONYM	COMPLETE TERM
CAT5e	Category 5 Cable
CAT6	Category 6 Cable
CAT7	Category 7 Cable
CEC	Consumer Electronics Control
DVI	Digital Visual Interface
HDCP	High-bandwidth Digital Content Protection
HDMI	High-Definition multimedia Interface
IR	Infrared
PoE	Power over Ethernet



CYP (UK) Ltd., Unit 7, Shepperton Business Park, Govett Avenue, Shepperton,
Middlesex, TW17 8BA

Tel: +44 (0) 20 3137 9180 | Fax: +44 (0) 20 3137 6279

Email: sales@cypeurope.com

www.cypeurope.com

v1.01