



**UHDBT™**  
ASE  
**4K HDR**  
**HDCP 2.2**



## **PUV-3050RX-UA**

**UHD+ HDMI Over HDBaseT3 Receiver  
with Analogue Audio I/O & USB 2.0**

**OPERATION MANUAL**



**HDMI**<sup>®</sup>  
HIGH-DEFINITION MULTIMEDIA INTERFACE

The terms HDMI, HDMI High-Definition Multimedia Interface, and the HDMI Logo are trademarks or registered trademarks of HDMI Licensing Administrator, Inc.

## **DISCLAIMERS**

The information in this manual has been carefully checked and is believed to be accurate. CYP (UK) Ltd assumes no responsibility for any infringements of patents or other rights of third parties which may result from its use.

CYP (UK) Ltd assumes no responsibility for any inaccuracies that may be contained in this document. CYP (UK) Ltd also makes no commitment to update or to keep current the information contained in this document.

CYP (UK) Ltd reserves the right to make improvements to this document and/or product at any time and without notice.

## **COPYRIGHT NOTICE**

No part of this document may be reproduced, transmitted, transcribed, stored in a retrieval system, or any of its part translated into any language or computer file, in any form or by any means—electronic, mechanical, magnetic, optical, chemical, manual, or otherwise—without express written permission and consent from CYP (UK) Ltd.

© Copyright 2021 by CYP (UK) Ltd.

All Rights Reserved.

Version 1.1

## **TRADEMARK ACKNOWLEDGMENTS**

All products or service names mentioned in this document may be trademarks of the companies with which they are associated.

---



## SAFETY PRECAUTIONS

Please read all instructions before attempting to unpack, install or operate this equipment and before connecting the power supply. Please keep the following in mind as you unpack and install this equipment:

- Always follow basic safety precautions to reduce the risk of fire, electrical shock and injury to persons.
- To prevent fire or shock hazard, do not expose the unit to rain, moisture or install this product near water.
- Never spill liquid of any kind on or into this product.
- Never push an object of any kind into this product through any openings or empty slots in the unit, as you may damage parts inside the unit.
- Do not attach the power supply cabling to building surfaces.
- Use only the supplied power supply unit (PSU). Do not use the PSU if it is damaged.
- Do not allow anything to rest on the power cabling or allow any weight to be placed upon it or any person walk on it.
- To protect the unit from overheating, do not block any vents or openings in the unit housing that provide ventilation and allow for sufficient space for air to circulate around the unit.
- Please completely disconnect the power when the unit is not in use to avoid wasting electricity.

## VERSION HISTORY

REV.	DATE	SUMMARY OF CHANGE
<b>RDV1</b>	2021/12/06	Preliminary release
<b>RDV1</b>	27/10/2022	New IR/RS-232 Diagrams

# CONTENTS

<b>1. Introduction</b> .....	<b>1</b>
<b>2. APPLICATIONS</b> .....	<b>1</b>
<b>3. PACKAGE CONTENTS</b> .....	<b>1</b>
<b>4. SYSTEM REQUIREMENTS</b> .....	<b>1</b>
<b>5. Features</b> .....	<b>2</b>
<b>6. Operation Controls and Functions</b> .....	<b>3</b>
6.1 Front Panel .....	3
6.2 Rear Panel.....	4
6.3 IR Cable Pinouts .....	5
6.4 Serial Pinout .....	5
6.5 Audio Pinouts.....	5
<b>7. Connection Diagram</b> .....	<b>6</b>
<b>8. Specifications</b> .....	<b>7</b>
8.1 Technical Specifications .....	7
8.2 Video Specifications.....	8
8.3 Audio Specifications.....	10
8.3.1 Digital Audio .....	10
8.3.2 Analogue Audio .....	10
8.4 Cable Specifications .....	11
8.5 HDBaseT Features.....	12
<b>9. Acronyms</b> .....	<b>13</b>

---



## 1. INTRODUCTION

This 4K UHD<sup>+</sup> HDMI over HDBaseT receiver uses HDBaseT 3.0, the newest generation of HDBaseT technology, and is the perfect solution for extending full bandwidth (18Gbps) HDMI 2.0, 4K@60Hz (4:4:4, 8-bit) video with HD audio via a single run of Cat.6A/7 cable over distances of up to 40 meters. Multiple control and data signals may also be transmitted along with the audio and video, including IR, RS-232, and USB 2.0. This receiver is ideal for use in any video extension scenario, especially when latency-free, uncompressed, high resolution video is critical, such as medical installations, live conferences, and education.

When used with its matched transmitter, 2 micro USB host connections are available (1 on the transmitter, 1 on the receiver) for connecting a single USB host (such as a laptop or PC) to devices on up to 4 USB 2.0 (Type-A) ports (2 on the transmitter, 2 on the receiver) forming a highly flexible KVM extension configuration.

## 2. APPLICATIONS

- /// Household entertainment sharing and control
- /// Lecture hall/classroom display and control
- /// Meeting room presentation and control

## 3. PACKAGE CONTENTS

- /// 1× UHD<sup>+</sup> HDMI over HDBaseT Receiver with USB KVM
- /// 2× 3-pin Terminal Block
- /// 1× 8-pin Terminal Block
- /// 1× Operation Manual

## 4. SYSTEM REQUIREMENTS

- /// A compatible HDBaseT transmitter with PoH (PSE) support is required.
- /// HDMI receiving equipment such as an HDTV, monitor, or audio amplifier.
- /// The use of Premium High Speed HDMI cables, and industry standard Cat.6A or Cat.7 Ethernet cable is highly recommended.

## 5. FEATURES

- /// HDMI 2.0 and DVI 1.0 compatible
- /// HDCP 2.2 and HDCP 1.x compliant
- /// HDBaseT 3.0 compliant (Backwards compatible with HDBaseT 2.0/1.0)
- /// 1 HDMI input, 1 HDMI output, and 1 HDBaseT input
- /// Supports up to 4K UHD<sup>+</sup> (18Gbps, 4K@60Hz 4:4:4, 8-bit) video input and output over both HDMI and HDBaseT
- /// Supports Deep Colour input and output up to 12-bit
- /// Supports 10-bit and 12-bit HDR (High Dynamic Range) input/output
- /// Supports CEC bypass/extract
- /// HDBaseT extends video, audio and data over a single Cat.6A/7 cable and can reach distances up to 40m/131ft
- /// HDBaseT feature support: HD Video and Audio, PoH (PD), Bi-directional audio (analogue), and Control (bi-directional USB/IR/RS-232 pass-through)
- /// 2 USB 2.0 Type-A device ports and 1 Micro USB host port
- /// Selectable HDMI audio extraction/analogue audio bypass functionality when paired with a compatible transmitter
- /// Powered directly via PoH from the connected transmitter

## 6. OPERATION CONTROLS AND FUNCTIONS

### 6.1 Front Panel

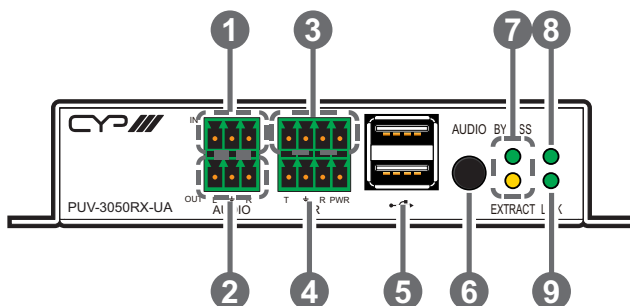

- 1 **AUDIO IN 3-pin Terminal Block:** Connect to the analogue audio output of a device such as a media player or game console using a 3-pin adapter cable. Audio is sent to the analogue audio output on the connected compatible receiver.
- 2 **AUDIO OUT 3-pin Terminal Block:** Connect to powered speakers or an amplifier for analogue audio output using a 3-pin adapter cable. Audio is sourced from the analogue audio input on the connected compatible receiver.
- 3 **RS-232 4-pin Terminal Block:** Connect to a PC, laptop, or serial controllable device with a 4-pin adapter cable for the extension of RS-232 signals between both ends of the HDBaseT connection.
- 4 **IR 4-pin Terminal Block (In/Out):** Connect to both an IR Blaster and Extender using a 4-pin Y-adapter cable to transmit and receive IR control signals and extend them to devices connected to the other end of the HDBaseT connection.
- 5 **USB 2.0 Ports (Type-A):** Connect directly to standard USB devices such as a mouse, keyboard, or flash drive to extend their USB functionality to the currently active Micro-USB host port.
- 6 **AUDIO Button:** Press this button to toggle the connected transmitter's analogue audio stream source between the analogue audio input (bypass) and the HDMI input's audio (extract).

*Note: HDMI audio extraction is only available with LPCM 2.0 sources. This feature requires connection to a fully compatible transmitter.*



- 7 **BYPASS & EXTRACT LEDs:** These LEDs will illuminate to indicate if the unit is in audio bypass or extract mode.
- 8 **POWER LED:** This LED will illuminate to indicate the unit is on and receiving power.
- 9 **LINK LED:** This LED will illuminate solidly when a live connection with a compatible transmitter is active.

## 6.2 Rear Panel

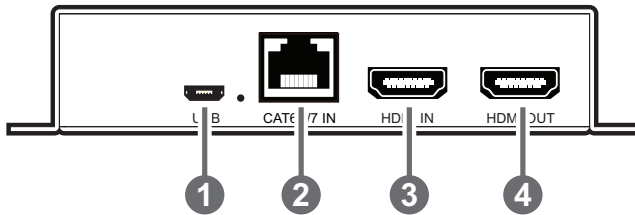

- 1 **USB 2.0 Port (Micro-B) & LED:** Connect directly to a standard USB host such as a PC or laptop to extend their USB functionality to all currently connected USB devices on both ends of the HDBaseT connection. The LED will illuminate solidly to indicate when the USB port is active.  
*Note: If USB hosts are connected to both the transmitter and receiver at the same time, only the most recently connected host will be active.*
- 2 **CAT6A/7 IN Port:** Connect to a compatible HDBaseT transmitter with a single Cat.6A/7 cable for extension of all data signals. Power via PoH will also be supplied to this unit when connected to a compatible PSE transmitter.  
*Note: A compatible PoH (PSE) transmitter is REQUIRED to power this receiver.*
- 3 **HDMI IN Port:** Connect to HDMI source equipment such as a media player, game console, or set-top box.  
*Note: If this HDMI input is connected, its video will automatically be output over the local HDMI output, overriding any current HDBaseT video source.*
- 4 **HDMI OUT port:** Connect to an HDMI TV, monitor, or amplifier for digital video and audio output.

### 6.3 IR Cable Pinouts

#### IR Blaster + IR Extender

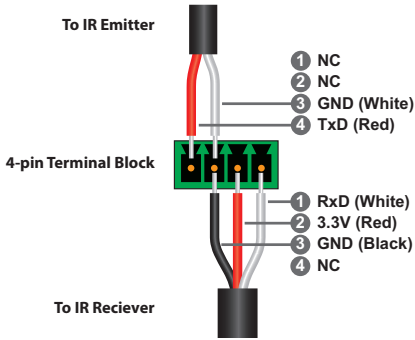

### 6.4 Serial Pinout

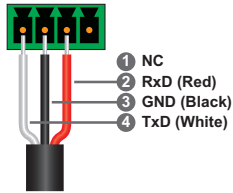

### 6.5 Audio Pinouts

#### Stereo Audio Input

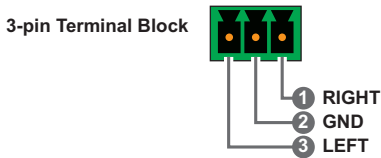

#### Stereo Audio Output

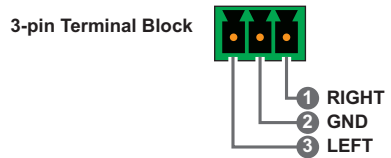

# 7. CONNECTION DIAGRAM

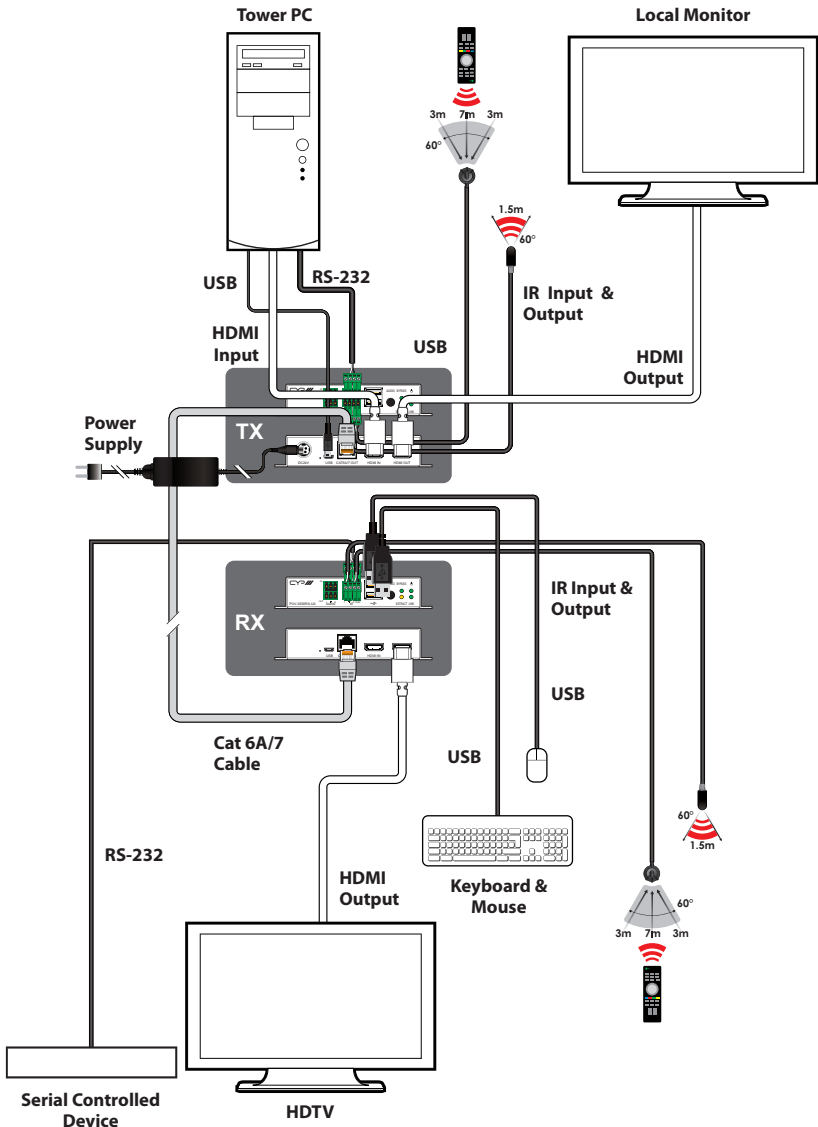

## 8. SPECIFICATIONS

### 8.1 Technical Specifications

<b>HDMI Bandwidth</b>	18Gbps
<b>HDBaseT Bandwidth</b>	18Gbps
<b>Input Ports</b>	1×HDBaseT (RJ-45) 1×HDMI (Type-A) 1×Analogue Stereo (3-pin Terminal Block)
<b>Output Ports</b>	1×HDMI (Type-A) 1×Analogue Stereo (3-pin Terminal Block)
<b>Pass-through Ports</b>	1×IR In/Out (4-pin Terminal Block) 1×RS-232 (4-pin Terminal Block) 2×USB 2.0 (Type-A)
<b>Pass-through/Service Port</b>	1×USB 2.0 (Micro-B)
<b>IR Frequency</b>	30 ~ 50kHz (30 ~ 60kHz under ideal conditions)
<b>Baud Rate</b>	Up to 115200
<b>Power Supply</b>	PoH (from Tx)
<b>ESD Protection (HBM)</b>	±8kV (Air Discharge) ±4kV (Contact Discharge)
<b>Dimensions (W×H×D)</b>	128mm×25mm×108mm [Case Only] 128mm×25mm×109.5mm [All Inclusive]
<b>Weight</b>	390g
<b>Chassis Material</b>	Metal (Steel)
<b>Chassis Colour</b>	Black
<b>Operating Temperature</b>	0°C – 50°C/32°F – 122°F
<b>Storage Temperature</b>	-20°C – 60°C/-4°F – 140°F
<b>Relative Humidity</b>	20 – 90% RH (Non-condensing)
<b>Power Consumption</b>	14W

## 8.2 Video Specifications

Supported Resolutions (Hz)	Input		Output
	HDMI	HDBT	HDMI
<b>720×400p@70/85</b>	✓	✓	✓
<b>640×480p@60/72/75/85</b>	✓	✓	✓
<b>720×480i@60</b>	✓	✓	✓
<b>720×480p@60</b>	✓	✓	✓
<b>720×576i@50</b>	✓	✓	✓
<b>720×576p@50</b>	✓	✓	✓
<b>800×600p@56/60/72/75/85</b>	✓	✓	✓
<b>848×480p@60</b>	✓	✓	✓
<b>1024×768p@60/70/75/85</b>	✓	✓	✓
<b>1152×864p@75</b>	✓	✓	✓
<b>1280×720p@50/60</b>	✓	✓	✓
<b>1280×768p@60/75/85</b>	✓	✓	✓
<b>1280×800p@60/75/85</b>	✓	✓	✓
<b>1280×960p@60/85</b>	✓	✓	✓
<b>1280×1024p@60/75/85</b>	✓	✓	✓
<b>1360×768p@60</b>	✓	✓	✓
<b>1366×768p@60</b>	✓	✓	✓
<b>1400×1050p@60</b>	✓	✓	✓
<b>1440×900p@60/75</b>	✓	✓	✓
<b>1600×900p@60RB</b>	✓	✓	✓
<b>1600×1200p@60</b>	✓	✓	✓
<b>1680×1050p@60</b>	✓	✓	✓
<b>1920×1080i@50/60</b>	✓	✓	✓

Supported Resolutions (Hz)	Input		Output
	HDMI	HDBT	HDMI
<b>1920×1080p@24/25/30</b>	✓	✓	✓
<b>1920×1080p@50/60</b>	✓	✓	✓
<b>1920×1200p@60RB</b>	✓	✓	✓
<b>2560×1440p@60RB</b>	✓	✓	✓
<b>2560×1600p@60RB</b>	✓	✓	✓
<b>2048×1080p@24/25/30</b>	✓	✓	✓
<b>2048×1080p@50/60</b>	✓	✓	✓
<b>3840×2160p@24/25/30</b>	✓	✓	✓
<b>3840×2160p@50/60 (4:2:0)</b>	✓	✓	✓
<b>3840×2160p@24, HDR10</b>	✓	✓	✓
<b>3840×2160p@50/60 (4:2:0), HDR10</b>	✓	✓	✓
<b>3840×2160p@50/60</b>	✓	✓	✓
<b>4096×2160p@24/25/30</b>	✓	✓	✓
<b>4096×2160p@50/60 (4:2:0)</b>	✓	✓	✓
<b>4096×2160p@24, HDR10</b>	✓	✓	✓
<b>4096×2160p@50/60 (4:2:0), HDR10</b>	✓	✓	✓
<b>4096×2160p@50/60</b>	✓	✓	✓

## 8.3 Audio Specifications

### 8.3.1 Digital Audio

HDMI & HDBaseT Input / HDMI Output	
LPCM	
<b>Max Channels</b>	8 Channels
<b>Sampling Rate (kHz)</b>	32, 44.1, 48, 88.2, 96, 176.4, 192
Bitstream	
<b>Supported Formats</b>	Standard & High-Definition

### 8.3.2 Analogue Audio

Analogue Input	
<b>Max Audio Level</b>	2Vrms
<b>Impedance</b>	10k $\Omega$
<b>Type</b>	Unbalanced
Analogue Output	
<b>Max Audio Level</b>	2Vrms
<b>THD+N</b>	< -80dB@0dBFS 1kHz (A-wt)
<b>SNR</b>	> 80dB@0dBFS
<b>Frequency Response</b>	< $\pm 0.5$ dB@20Hz~20kHz
<b>Crosstalk</b>	< -71dB@10kHz
<b>Impedance</b>	499 $\Omega$
<b>Type</b>	Unbalanced

## 8.4 Cable Specifications

Cable Length	1080p		4K30	4K60
	8-bit	12-bit	(4:4:4) 8-bit	(4:4:4) 8-bit
<b>High Speed HDMI Cable</b>				
<b>HDMI Input</b>	10m	10m	5m	3m
<b>HDMI Output</b>	10m	10m	5m	3m
<b>Ethernet Cable</b>				
<b>Cat.5e/6</b>	*			N/A
<b>Cat.6A/7</b>	40m			

*\*Results with Cat 5e/6 will vary*

### Bandwidth Category Examples:

#### 1080p (FHD Video)

- Up to 1080p@60Hz, 12-bit colour
- Data rates lower than 5.3Gbps or below 225MHz TMDS clock

#### 4K30 (4K UHD Video)

- 4K@24/25/30Hz & 4K@50/60Hz (4:2:0), 8-bit colour
- Data rates higher than 5.3Gbps or above 225MHz TMDS clock but below 10.2Gbps

#### 4K60 (4K UHD+ Video)

- 4K@50/60Hz (4:4:4, 8-bit)
- 4K@50/60Hz (4:2:0, 10-bit HDR)
- Data rates higher than 10.2Gbps



## 8.5 HDBaseT Features

HDBaseT Feature Set	Receiver
<b>Video &amp; Audio Extension</b>	Supported
<b>LAN Extension</b>	Unsupported
<b>Send power to Transmitter</b>	Unsupported
<b>Accept power from Transmitter</b>	Supported (PoH)
<b>IR Extension</b>	Supported
<b>RS-232 Extension</b>	Supported
<b>USB 2.0 Extension</b>	Supported

## 9. ACRONYMS

ACRONYM	COMPLETE TERM
<b>4K UHD</b>	4K Ultra-High-Definition (10.2Gbps max)
<b>4K UHD<sup>+</sup></b>	4K Ultra-High-Definition (18Gbps max)
<b>AVoIP</b>	Audio/Video over IP
<b>Cat.5e</b>	Enhanced Category 5 cable
<b>Cat.6</b>	Category 6 cable
<b>Cat.6A</b>	Augmented Category 6 cable
<b>Cat.7</b>	Category 7 cable
<b>DVI</b>	Digital Visual Interface
<b>EDID</b>	Extended Display Identification Data
<b>GbE</b>	Gigabit Ethernet
<b>Gbps</b>	Gigabits per second
<b>HDBT</b>	HDBaseT
<b>HDCP</b>	High-bandwidth Digital Content Protection
<b>HDMI</b>	High-Definition Multimedia Interface
<b>HDR</b>	High Dynamic Range
<b>IR</b>	Infrared
<b>kHz</b>	Kilohertz
<b>LED</b>	Light-Emitting Diode
<b>LPCM</b>	Linear Pulse-Code Modulation
<b>MHz</b>	Megahertz
<b>PD</b>	Powered Device
<b>PoH</b>	Power over HDBaseT
<b>PSE</b>	Power Sourcing Equipment
<b>TMDS</b>	Transition-Minimized Differential Signaling

ACRONYM	COMPLETE TERM
<b>USB</b>	Universal Serial Bus
<b>VGA</b>	Video Graphics Array
<b>WUXGA (RB)</b>	Widescreen Ultra Extended Graphics Array (Reduced Blanking)
<b>XGA</b>	Extended Graphics Array



---

CYP (UK) Ltd., Unit 7, Shepperton Business Park, Govett Avenue,  
Shepperton, Middlesex, TW17 8BA

Tel: +44 (0) 20 3137 9180 | Fax: +44 (0) 20 3137 6279

Email: [sales@cypeurope.com](mailto:sales@cypeurope.com)

[www.cypeurope.com](http://www.cypeurope.com)

RDV1.1