

Detailed Operating Instructions

Introduction ([introduction/index.html](#))

- ▶ Safety Precautions ([introduction/safety_precautions/index.html](#))
- ▶ Regulatory ([introduction/regulatory/index.html](#))
- ▶ NOTICES ([introduction/notices/index.html](#))
- ▶ Package Contents ([introduction/package_contents/index.html](#))

Before You Begin ([about_this_product/index.html](#))

- ▶ Parts of the Projector: Names and Functions ([about_this_product/parts/index.html](#))
- ▶ The Remote Control ([about_this_product/remote_control/index.html](#))
- ▶ Basic Operation ([about_this_product/basic_usage/index.html](#))
- ▶ Warping (Geometric Correction) and Edge Blending
([about_this_product/warping_blending/index.html](#))

Installation ([installation/index.html](#))

- ▶ Overview ([installation/installation_overview/index.html](#))
- ▶ Positioning and Focusing the Image ([installation/adjust_projection_state/index.html](#))
- ▶ Connections ([installation/connections/index.html](#))

Menus ([menu/index.html](#))

- ▶ Menu List ([menu/menu_list/index.html](#))
- ▶ Using the Menus ([menu/use_menu/index.html](#))
- ▶ DISPLAY ([menu/display/index.html](#))
- ▶ PICTURE ([menu/picture/index.html](#))
- ▶ SOURCE ([menu/source/index.html](#))
- ▶ SYSTEM SETUP : Basic ([menu/system_setup_basic/index.html](#))
- ▶ SYSTEM SETUP : Advanced ([menu/system_setup_advanced/index.html](#))
- ▶ INFORMATION ([menu/information/index.html](#))

Using the Warping and Blending Tool (FP-Z8000 only) ([warping_blending/index.html](#))

- ▶ Overview ([warping_blending/overview_wab/index.html](#))
- ▶ Workflow ([warping_blending/usage/index.html](#))
- ▶ Installation ([warping_blending/install/index.html](#))
- ▶ Connections ([warping_blending/connection_wab/index.html](#))
- ▶ Launch and Setup ([warping_blending/basic_setting/index.html](#))
- ▶ Warping (Geometric Correction) ([warping_blending/warping/index.html](#))
- ▶ Blending (Edge Blending) ([warping_blending/blending/index.html](#))
- ▶ Color (Color Correction) ([warping_blending/color/index.html](#))

▶ [Painting \(warping_blending/painting/index.html\)](#)

▶ [Saving and Loading Project Info \(warping_blending/information_save_call/index.html\)](#)

Technical Notes (technical_notes/index.html)

▶ [Main Specifications \(technical_notes/spec/index.html\)](#)

▶ [Supported Resolutions \(technical_notes/support_resolution/index.html\)](#)

▶ [Projection Distance \(technical_notes/projection_distance/index.html\)](#)

▶ [Geometric Correction Range \(technical_notes/geometric_correction/index.html\)](#)

▶ [PJLink Commands \(technical_notes/pjlink/index.html\)](#)

▶ [Projector control \(technical_notes/contro_command/index.html\)](#)



▶ [Trademark Information \(technical_notes/trademark/index.html\)](#)

Safety Precautions

▼ For Your Safety

▼ Safe Use of Lasers

For Your Safety

The  **WARNING** and  **CAUTION** indications in this document indicate the following:

 **WARNINGS** Failure to observe warnings could result in death or serious injury.

 **CAUTIONS** Failure to observe cautions could result in injury or property damage.

This section lists important precautions that must be followed to ensure safe and correct use of the product. Read them before using the product and observe them during use.

WARNINGS

- Be sure the product is installed securely. Serious accidents could result should the product fall from a height.
- Ceiling installations (where the product is suspended from the ceiling) should be performed only by professionals with the requisite skills. If installed incorrectly, the product could fall, potentially causing a serious accident.
- When working in high places, work with at least one partner, use a safety line, and take all other precautions necessary to ensure safety. Slipping, falling, or loss of balance could result in serious accidents.
- When installing the product in high places, ensure that people below keep their distance. Falling objects could cause serious accidents.
- Do not install or use the product in a bath or shower. Failure to observe this precaution could result in fire or electric shock.
- Do not handle the product with wet hands. Failure to observe this precaution could result in electric shock.
- Do not modify, tug, or twist the connecting cables, subject them to excessive heat, or place them under heavy objects. Damage to the cables could result in fire or electric shock. Should the cables be damaged, contact a Fujifilm-authorized service technician. Keep the cables clear of the intake and exhaust vents.
- Do not use cables if their connectors have ever been bent.
- Do not place the product on unstable surfaces. Be sure the product is level. Injury could result if the product tips or falls.
- Do not touch the metal parts of the product during thunderstorms. Lightning strikes can produce induced current that could cause electric shock.
- Do not place vessels containing water, chemicals, or other liquids on the product. Liquid that finds its way into the product could cause fire or electric shock.
- Never look directly into the lens while the product is on. The bright light could cause visual impairment or other injury. Do not look into the lens with magnifying glasses, telescopes, or other optical instruments.
- Do not insert flammable material, metal, or other foreign objects into the product or leave them in its vicinity. Failure to observe this precaution could result in fire, burns, or electric shock.
- Do not use sprays containing flammable gas to remove dust or other foreign matter from the lens. The gas could ignite, causing fire.
- Do not use the product in locations where the air may contain flammable or explosive gases. The gases could ignite, causing fire.
- Do not place flammable objects in front of the lens. Failure to observe this precaution could result in fire.
- This apparatus must be grounded.
- Do not block the light from the product with books, cloths, or other objects. Objects placed in the beam could become hot, potentially melting or causing burns or fire. Light reflected from the objects could also cause the lens to overheat, causing product malfunction.
- Do not touch the lens or metal parts of the product while it is on or immediately after it has been switched to standby. Failure to observe this precaution could result in burns or other injury.
- Be careful not to drop the product when lifting it.
- Should you notice that the product is not functioning normally, switch it to standby and disconnect the power and USB cables. Continuing to use the product when it is emitting smoke or unusual smells or otherwise functioning abnormally could result in fire, electric shock, or visual impairment.

- Use only the supplied power cord. Using other cables could cause overheating or an electrical short leading to fire or electric shock. Failure to properly ground the outlet to which the supplied power cord is connected could also result in electric shock.

CAUTIONS

- Use the product only as described in this manual.
- The product and its accessories are precision devices. Under no circumstances should they be subjected to excessive force.
- Replace the lens cap if the product will not be used for an extended period.
- The lens includes moving parts: do not apply excessive force or subject the lens to physical shocks.
- Do not install this product in locations that are dusty, humid, or exposed to soot, steam, or sources of heat. Failure to observe this precaution could result in fire or electric shock. In addition, grease could cause the projector's plastic casing to deteriorate, damaging the supports and potentially causing the product to fall.
- Do not leave the product in locations where it will be exposed to high temperatures or direct sunlight. Failure to observe this precaution could result in fire.
- Do not leave the product or, if the batteries are inserted, the remote control unattended in locations exposed to direct sunlight or high temperatures, for example directly in the path of warm air from a heater. Excessive heat could deform the casing or damage the product's internal parts, resulting in fire.
- Do not place heavy objects on the product. The objects could become unbalanced and tip or fall, causing injury.
- Do not use the power cord if the plug is damaged or does not fit securely into the socket. Failure to observe this precaution could result in fire or electric shock.
- Keep your face and hands, as well as objects that may be warped or otherwise damaged by heat, away from the exhaust vent while the product is in use. The hot air from the vent could deform the objects or cause burns or accidents.
- For safety, be sure to unplug the product when it is not in use. Failure to observe this precaution could result in fire due to deterioration of the insulation or other causes.
- Before transporting or cleaning the product, switch it to standby, unplug it from the power outlet, and disconnect all cables. Failure to observe this precaution could result in fire or electric shock.
- When cleaning the product, do not use damp cloths or solvents such as alcohol, benzene (petroleum ether), or thinner. Water could enter the product or the casing could weaken and break or suffer other damage, potentially resulting in electric shock.
- The accumulation of dust inside the product could result in fire or malfunction. We recommend that the interior of the product be periodically inspected and cleaned. Contact the original retailer for these services.
- Do not lift the product by the lens. Failure to observe this precaution could damage the product.
- When using the product at high altitudes (above 1,500 m/4,900 ft), enable high-altitude mode to ensure that the product's internal temperature-control mechanism functions correctly. Failure to observe this precaution could shorten the life of the product's parts.
- Should you notice that the product is not functioning normally, switch it to standby and disconnect the power and USB cables. Continuing to use the product when it is emitting smoke or unusual smells or otherwise functioning abnormally could result in fire, electric shock, or visual impairment. Consult the original retailer.
- Do not drop water or foreign objects into the product. Should water or other foreign matter find its way in to the interior, switch the product to standby and unplug it from the power outlet. Continued use could result in a short circuit causing fire or electric shock. Consult the original retailer.
- Do not disassemble or modify the product (never open the case). Failure to observe this precaution could result in fire or electric shock.
- Keep small parts out of the hands of infants and pets. Because of their size, small objects such as batteries from the remote control may be accidentally swallowed by infants or pets. Keep small parts out of their reach. Should an infant swallow any part of the product, consult a physician immediately.
- Keep safety in mind when stringing cables. Failure to observe this precaution could result in falls or injury.
- Do not install the product in locations subject to shock or vibration.
- Do not touch the lens immediately after switching the product to standby. Failure to observe this precaution could result in burns.
- Be sure the product is properly grounded.
- The plastic bags provided with this product present a suffocation risk when placed over the nose and mouth. Store them out of reach of infants and young children.

Precautions for Storage and Use

- Do not use or store the product in locations subject to extreme temperatures. Avoid locations that are subject to sudden changes in temperature. Operate and store the product within its operating and storage temperature limits.
- Do not install the product in the vicinity of high-voltage power lines or equipment that produces magnetic fields. The product may not function as expected.

- Do not use the product when it is tilted. Failure to observe this precaution could damage the product or cause accidents.
- Do not touch the lens with your bare hands. Fingerprints and smudges on the lens can affect picture quality. To keep the lens clean and free of scratches, replace the lens cap when the product is not in use.
- Remove the batteries from the remote control before placing it in storage. Leaving the batteries in place for long periods could result in leakage or other damage to the batteries.
- Do not use or store the product where it will be exposed to soot or tobacco smoke. Failure to observe this precaution could result in reduced picture quality.
- Malfunction or damage due to such causes as fire, earthquakes, floods, lightning, or other acts of God; man-made pollution or environmental disasters; salt; voltage fluctuations; or use of power sources operating at unauthorized voltages or frequencies is not covered under warranty.
- To clean the lens, first switch the product to standby and wait for the lens and metal parts to cool, then remove dust and lint with a blower before gently wiping the lens with a third-party glass-cleaning cloth or the like.
- Allow the lens to cool before performing cleaning.
- When transporting the product, hold it by its base. Do not hold it by the lens or the opening around the lens. Failure to observe this precaution could damage the product.
- Thread-locking adhesive, lubricants, or grease on the ceiling mounts could cause the projector's plastic casing to deteriorate, potentially damaging the product or causing it to fall.
- Do not install or store the product where it will be exposed to salt damage or corrosive gases. Corrosion could damage the product or cause it to fall.

Safe Use of Lasers

This equipment is defined as a Class 1 laser product under IEC/EN60825-1:2014. Be sure to observe the following warnings and cautions.

WARNINGS

- This product contains a laser; do not open the case.
- Bright light can cause visual impairment or other injury; do not look directly at the light source. In the event that you do look directly at the light source, consult a physician as required.
- Never attempt to remodel or disassemble the projector. High voltages can cause fire or electric shocks.

CAUTIONS

- Dispose of this product in accord with location regulations; do not disassemble.
- Use of controls or adjustments or performance of procedures other than those specified herein may result in hazardous radiation exposure.
- As with any bright source, do not stare into the direct beam, RG2 IEC 62471-5:2015.

Lens RG2



Notes on the Laser

This product uses a laser as a light source, which has the following characteristics:

- The light source may dim under certain conditions.
- The higher the temperature, the more the source will dim.
- The source will grow dimmer the longer it is used.
- The relation between source brightness and length of use can be adjusted using brightness settings.
- To prevent exposure to harmful laser light, consult an authorized service center should the projector require inspection, adjustment, or repair.
- The projector is equipped with a built-in laser module. Follow the instructions in the product manual when operating the projector or adjusting settings.
- Be sure to remove the lens cap before turning the projector on. The lens cap could be damaged if left in place when the projector is turned on and the laser powers up.
- Regardless of their distance from the projector, children should never be allowed to stare into the beam.
- Before turning the projector on, check to be sure that no one is standing in front of the lens.
- Do not use optical instruments such as telescopes or binoculars while the projector is in operation.

Laser Warning Stickers

Laser warning stickers are affixed to the bottom and side of the product.

Side

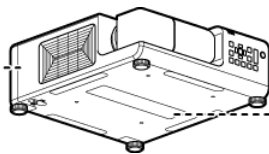

Bottom

Specifications of Laser Source

■ FP-Z8000

- **Wavelength:** 455 nm
- **Maximum Output:** 74 W

■ FP-Z6000

- **Wavelength:** 455 nm
- **Maximum Output:** 105 W

Regulatory

This product conforms to the following regulations related to product safety, environmental requirements and electromagnetic compatibility (EMC).

- ▼ Safety
- ▼ Laser Safety
- ▼ Electro-Magnetic Compatibility
- ▼ Environmental
- ▼ Marking

Safety

- CSA C22.2 No. 60950-1, 62368-1
- UL 60950-1, 62368-1
- IEC 60950-1, 62368-1
- EN 60950-1, 62368-1

Laser Safety

- IEC 60825-1
- IEC 62471
- FDA CDRH CFR 1040.10
- FDA CDRH CFR 1040.11

Electro-Magnetic Compatibility

Emissions

- FCC CFR47, Part 15, Subpart B/ANSI C63.4, Class A - Unintentional Radiators
- CISPR32/EN55032 Class A - Information Technology Equipment
- ICES/NMB003 (A) - Information Technology Equipment

Immunity

- CISPR 24/EN55024 EMC Requirements - Information Technology Equipment

Environmental

- The product conforms to:
 - EU Directive (2011/65/EU) on the restriction of the use of certain hazardous substances (RoHS) in electrical and electronic equipment and the applicable official amendment(s).
 - EU Regulation (EC) No. 1907/2006 on the registration, evaluation, authorization and restriction of chemicals (REACH) and the applicable official amendment(s).
 - EU Directive (2012/19/EU) on waste and electrical and electronic equipment (WEEE) and the applicable official amendment(s).
 - China Ministry of Information Industry Order No.39 (02/2006) on the control of pollution caused by electronic information products, the hazardous substances concentration limits (SJ/T11363-2006), and the applicable product marking requirement (SJ/T11364-2006).

Marking

- This product conforms to all relevant Canadian, US, and European directives, standards, safety, health and environmental concerns. International packaging recycling marks conform to:
 - EU Directive (2012/19/EU) on waste and electrical and electronic equipment (WEEE).
 - EU Directive (94/62/EC) on packaging and packaging waste.
 - China packaging recycling mark standard (GB18455-2001).

NOTICES

Verification

Model Number: FP-Z8000/FP-Z6000

Trade Mark: Fujifilm

Address: 200 Summit Lake Drive, Valhalla, NY 10595-1356, U.S.A.

Tel: 019147898100

This device complies with Part 15 of the FCC Rules. Operation is subject to the following two conditions: (1) this device may not cause harmful interference, and (2) this device must accept any interference received, including interference that may cause undesired operation.

Caution:This equipment has been tested and found to comply with the limits for a Class A digital device, pursuant to part 15 of the FCC Rules. These limits are designed to provide reasonable protection against harmful interference when the equipment is operated in a commercial environment. This equipment generates, uses, and can radiate radio frequency energy and, if not installed and used in accordance with the instruction manual, may cause harmful interference to radio communications. Operation of this equipment in a residential area is likely to cause harmful interference in which case the user will be required to correct the interference at his own expense.

FCC Warning:To assure continued compliance, follow the attached installation instructions. This includes using the provided power cord and shielded interface cables when connecting to computer or peripheral devices. Also, any unauthorized changes or modifications to this equipment could void the user's authority to operate this device.

-
- ▼ Federal Communications Commission (FCC) Warning
 - ▼ For Customers in Canada
 - ▼ For Customers in New Zealand and Australia
 - ▼ For Customers in Taiwan
 - ▼ For Customers in Korea
 - ▼ For Customers in Japan
 - ▼ For Customers in UK
 - ▼ For Customers in the EU
 - ▼ About the Icons
 - ▼ Disposal of Electrical and Electronic Equipment in Private Households in the European Union, Norway, Iceland and Liechtenstein:
 - ▼ Battery Safety Precautions

Federal Communications Commission (FCC) Warning

- A shielded-type power cord is required in order to meet FCC emission limits and also to prevent interference to the nearby radio and television reception. It is essential that only the supplied power cord be used.
- Use only shielded signal cables to connect I/O devices to this equipment.

For Customers in Canada

CAN ICES-3(A)/NMB-3(A)

This Class A digital apparatus complies with Canadian ICES-003.

Cet appareil numérique de la classe A est conforme à la norme NMB-003 du Canada.

For Customers in New Zealand and Australia

WARNING: This equipment is compliant with Class A of AS/NZS CISPR32. In a residential environment this equipment may cause radio interference.

For Customers in Taiwan

警告使用者:

此為甲類資訊技術設備，於居住環境中使用時，可能會造成射頻擾動，在此種情況下，使用者會被要求採取某些適當的對策。



廢電池請回收

請勿將電池當作一般垃圾丟棄。這個標誌表示電池不應視為一般垃圾丟棄。僅適用於台灣。

限用物質及化學符號表

設備名稱： 投影機						
單元	限用物質及其化學符號					
	鉛 (Pb)	汞 (Hg)	鎘 (Cd)	六價鉻 (Cr ¹⁶)	多溴 聯苯 (PBB)	多溴二 苯醚 (PBDE)
印刷電路板	—	○	○	○	○	○
外殼	—	○	○	○	○	○
光學組件	—	○	○	○	○	○
電源供應單元	—	○	○	○	○	○
輸出入端子	—	○	○	○	○	○
附配件(遙控 器/電源線)	—	○	○	○	○	○

備考1. "○" 係指該項限用物質之百分比含量未超出百分比含量基準值。
備考2. "—" 係指該項限用物質為排除項目。

For Customers in Korea

사용자안내문.	이 기기는 업무용 환경에서 사용할 목적으로 적합성평가를 받은 기기로서 가정용 환경에서 사용하는 경우 전파간섭의 우려가 있습니다.
---------	---

For Customers in Japan

この装置は、クラスA機器です。この装置を住宅環境で使用すると電波妨害を引き起こすことがあります。この場合には使用者が適切な対策を講ずるよう要求されることがあります。 VCCI — A
--

For Customers in UK

UK Importer:
FUJIFILM UK Ltd.
St Martins Business Centre, St Martins Way, Bedford MK42 0LF, United Kingdom

For Customers in the EU

EU Importer:
FUJIFILM Electronic Imaging Europe GmbH
Fujistraße 1 47533 Kleve, Germany

This product complies with the following EU Directives:

- RoHS Directive 2011/65/EU,(EU)/2015/863
- EMC Directive 2014/30/EU
- LVD Directive 2014/35/EU

Compliance with these directives implies conformity to applicable harmonized European standards (European Norms) which are listed on the EU Declaration of Conformity issued by FUJIFILM Corporation for this product or product family.

This compliance is indicated by the following conformity marking placed on the product:





This marking is valid for non-Telecom products and EU harmonized Telecom products (e.g., Bluetooth).

Company name: FUJIFILM Europe GmbH
Address: Heesenstrasse 31, 40549 Dusseldorf, Germany
Tel: 04921150890

About the Icons

The symbols on the product represent the following:

	AC
	DC
	Class II equipment (The construction of the product is double-insulated.)

Disposal of Electrical and Electronic Equipment in Private Households in the European Union, Norway, Iceland and Liechtenstein:

This symbol on the product, or in the manual and in the warranty, and/or on its packaging indicates that this product shall not be treated as household waste. Instead it should be taken to an applicable collection point for the recycling of electrical and electronic equipment. By ensuring this product is disposed of correctly, you will help prevent potential negative consequences to the environment and human health, which could otherwise be caused by inappropriate waste handling of this product.



Battery Safety Precautions

- Batteries may explode if not correctly replaced. Replace only with batteries of the same or an equivalent type.
- Do not expose batteries, including those installed in a device or battery pack, to excessive heat, for example by leaving them in direct sunlight or exposing them to fire.
- Do not expose batteries to unpressurized environments at high altitudes or to extremely high or low temperatures during use, storage, or transport.
- Do not use batteries designed to defeat safeguards.
- Batteries may explode if thrown into a fire, left in a hot oven, crushed, or cut.
- Batteries may explode or leak flammable liquid or gas if exposed to extremely high temperatures or low pressures.

Package Contents

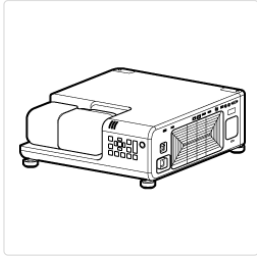

Projector

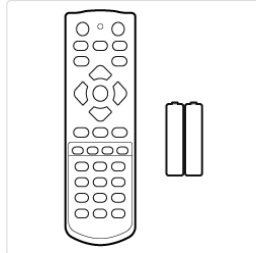

Remote control with two AAA batteries

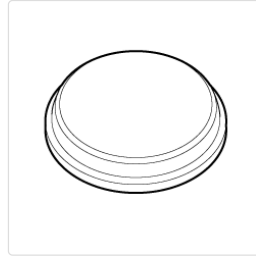

Lens cap

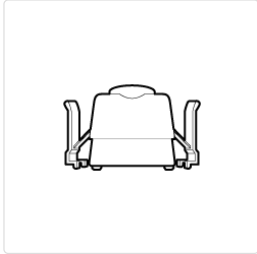

Power cord lock (x1)

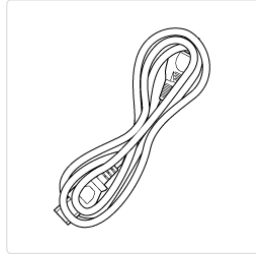

Power cord 3.0m (9.8ft)

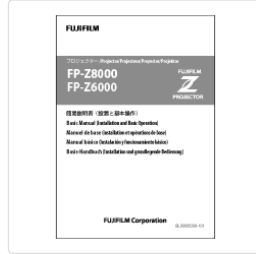

Basic Manual

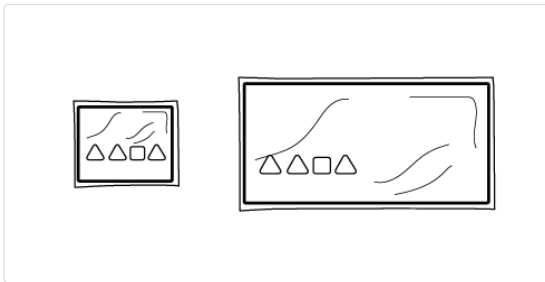

Lens covers (x2)

The projector ships with the lens covers in place. (The lens covers must also be attached to the projector during storage and transport.)

Parts of the Projector: Names and Functions

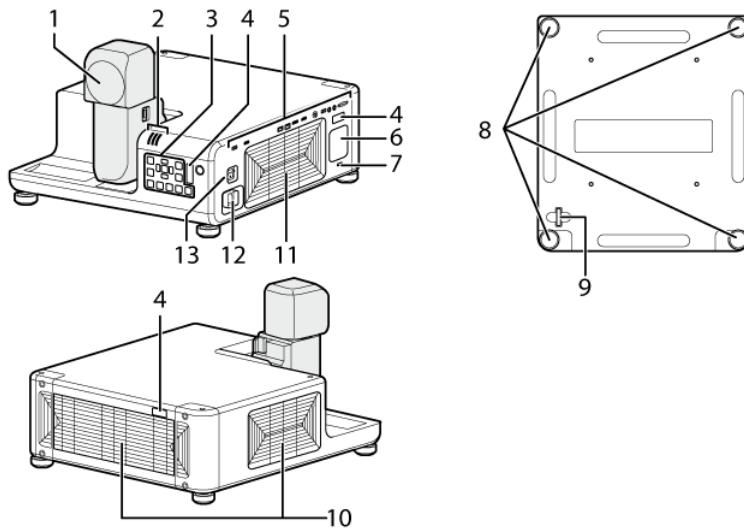

Item	Name
1	Lens
2	Indicator lamps
3	Control panel
4	Remote receiver
5	Interface (connector) panel
6	Speaker
7	Security slot *

Item	Name
8	Adjustable feet
9	Security lock
10	Intake vents
11	Exhaust vent
12	Power connector
13	Main power

* Compatible with Kensington MicroSaver security system locks.

- ▼ Control panel
- ▼ The Arm and Head Latches
- ▼ Connectors
- ▼ Indicator Lamps

Control panel

Basic operations are performed using the control panel. The names and functions of the buttons on the control panel are given below.

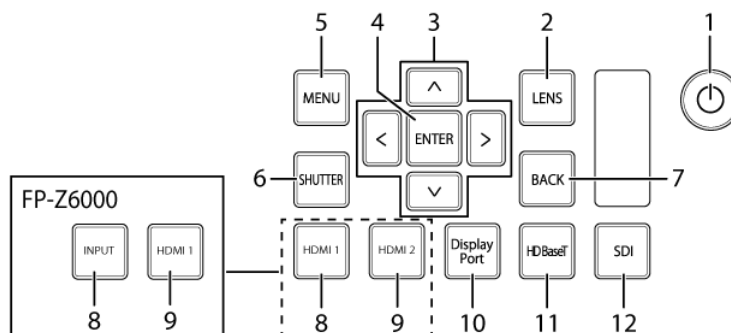

Item	Button	Function
1	(power)	Turn the projector on or switch it to standby. The projector automatically switches to standby about three seconds after the lens is returned to the storage position.
2	LENS	Adjust lens focus, shift, and zoom.

Item	Button	Function
3	Selector	Navigate the menus.
4	ENTER	Select the highlighted menu item.
5	MENU	Display the menus used to adjust projector settings.
6	SHUTTER	Temporarily suspend projection and mute audio. Press again to resume.
7	BACK	Return to the previous menu.
8	HDMI1	Select HDMI 1 (FP-Z8000).
	INPUT	Select an input source (FP-Z6000).
9	HDMI2	Select HDMI 2 (FP-Z8000).
	HDMI1	Select HDMI 1 (FP-Z6000).
10	DisplayPort	Select DisplayPort.
11	HDBaseT	Select HDBaseT.
12	SDI	Select SDI.

The Arm and Head Latches

The lens can be rotated and is equipped latches for the arm and projector head. Rotate the lens as described below. Be sure to latch the lens while projector is in use.

⚠ CAUTIONS

- Some portions of the projected image may not be visible depending on lens shift and the orientation of the lens.
- When rotated, the lens automatically returns to the previous shift position, causing the picture move. Do not rotate the lens while lens shift is in progress (i.e., while the image is moving).
- When rotating the lens, keep it supported and rotate it slowly.
- Pay attention to your surroundings when rotating the lens. Light from the product projected into the eyes could cause visual impairment.

Rotating the Arm

When the arm latch is disengaged by pressing the arm latch release, the arm can be rotated 90°. Lift the latch release to latch the arm once more.

- ① **Unlatch**
- ② **Latch**

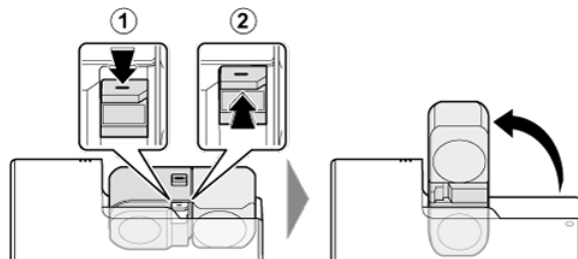

Rotating the Projector Head

When the head latch is disengaged by sliding the head latch release to the **FREE** position, the projector head can be rotated 360° in 90° increments.

- ① **FREE position**
- ② **LOCK position**



The lens can be rotated when the head latch release is in the FREE position and latches when the release is in the LOCK position.

⚠ CAUTION

Do not return the arm to the storage position with the lens facing down. Failure to observe this precaution could scratch or break the lens.

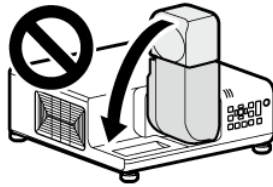

⚠ CAUTION: TRANSPORT AND STORAGE

Observe the following precautions to prevent the lens being scratched or broken during transport and storage.

- Return the lens to the home lens shift position. (Remote control: Hold the **SHIFT** button for 3 seconds.)
- Be sure to return the lens to the storage position.
- Attach the two protective covers (one large and one small) to the lens for transport.

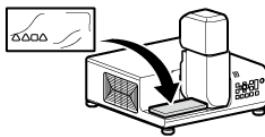

Large cover

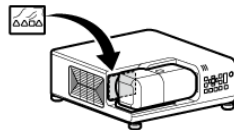

Small cover

Connectors

Connect devices to the connectors using the appropriate cables.

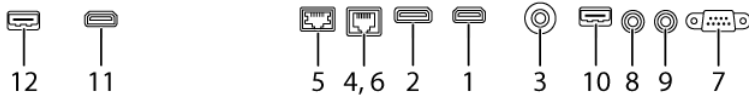

Connector		Description
Video IN	1	HDMI 1 IN HDMI 2.0 (compatible with HDCP 2.2, accepts 3840 × 2160 60P input)
	2	DisplayPort IN Display Port 1.2 (compatible HDCP 1.3, accepts 3840 × 2160 60P input)
	3	SDI IN BNC (3G/HD/SD SDI input)
	4	HDBaseT IN RJ-45 for video/audio/connection control (accepts 3840 × 2160 60P input)
Control IN/OUT	5	LAN RJ-45 for network connection (10Base-T/100Base-TX)
	6	HDBaseT IN RJ-45 for projector connection control
	7	RS-232C IN D-Sub 9 pin for projector connection control
Audio IN/OUT	8	AUDIO IN 3.5 mm stereo mini jack
	9	AUDIO OUT 3.5 mm stereo mini jack
Other	10	USB 1 Type A for maintenance, DC 5V 1.5A (Max)
Warping/edge blending function *1 (FP-Z8000 only)	11	HDMI 2 IN *2 HDMI 1.4 (compatible with HDCP 1.4, audio input not supported)
	12	USB 2 Type A for warping/edge blending function

*1 For information on connecting cables, see **☛ "Connections"** ([../warping_blending/connection_wab/index.html](#)).

*2 Input selection is made via software. At default settings, the input signal resolution is fixed at 1920 × 1200. Input at resolutions other than the selected value may produce unexpected results.

⚠ CAUTIONS

- Before connecting cables, switch the projector to standby and confirm that the peripheral is either off or in standby mode. After connecting the cable to both devices, turn the projector on first and then turn on the peripheral.
- Some devices require an adapter and/or a dedicated cable.

Indicator Lamps

Projector status is shown by whether the indicator (**ON/STANDBY**, **TEMP**, and **STATUS**) lamps are on, flashing, or off.

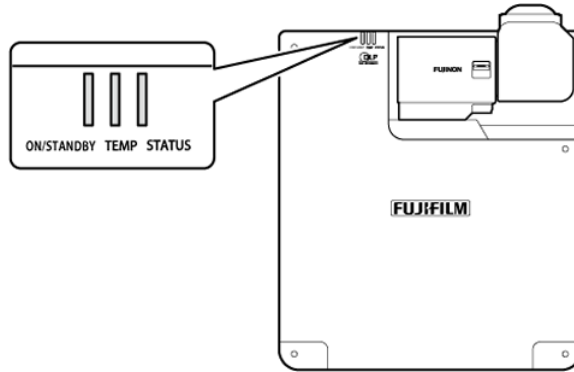

The statuses shown by the condition of the indicator lamps are listed below.

Lamp			Projector status
ON/STANDBY	TEMP	STATUS	
On (red)	Off	Off	Projector in standby mode.
On (green)	Off	Off	Projector on.
On (green)	Flashing (red)	Off	Projector temperature elevated.
Flashing (red)	Off	Off	Network standby.
On (green) or flashing (green) or off	On (red) or off	On (red) or flashing (red)	Problem with cooling fan.

The Remote Control

- ▼ The Remote Control Buttons and Their Functions
- ▼ Remote Control Reception Range
- ▼ Choosing IDs

The Remote Control Buttons and Their Functions

The names and functions of the buttons on the remote control are listed below.

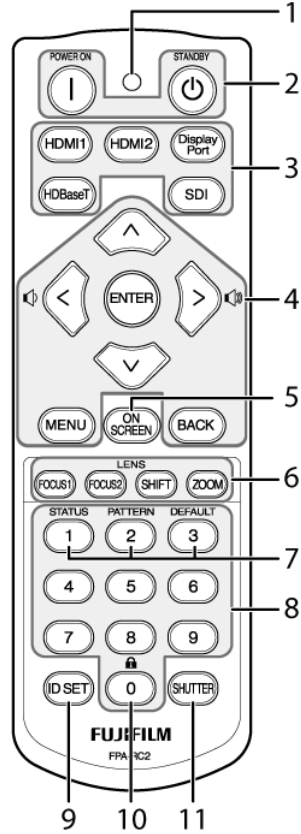

Item	Button	Function
1	Operation lamp	Flashes when buttons on the remote control are pressed.
2	POWER ON	Power (../about_this_product/basic_usage/index.html)
	STANDBY	Turn the projector on. Switch the projector to standby.
3	HDMI1	Select HDMI 1.
	HDMI2	Select HDMI 2 (FP-Z8000 only).
	DisplayPort	Select DisplayPort.
	HDBaseT	Select HDBaseT.
	SDI	Select SDI.
4	Selector (../menu/use_menu/index.html) (up, down, left, and right)	Navigate the menus.
	Volume (press the selector left and right)	Adjust the volume of the built-in speaker.
	ENTER	Select the highlighted menu item.

Item	Button	Function	
	MENU	Display the menus used to adjust projector settings.	
	BACK	Return to the previous menu.	
5	ON SCREEN	Hide the menus. Press again to view the menus once more.	
6	FOCUS1	Lens (../installation/adjust_projection_state/index.html)	Adjust overall focus.
	FOCUS2		Adjust focus at the edges of the picture.
	SHIFT		Adjust lens shift.
	ZOOM		Adjust zoom.
7	STATUS (../menu/information/index.html)	View projector information.	
	PATTERN (../menu/display/#test_pattern)	Display a test pattern. To choose the pattern, use the ◀▶ keys.	
	DEFAULT	Restore default settings for the selected menu item. This setting can only be adjusted using the remote control. This button cannot be used to reset the following to default values: <ul style="list-style-type: none"> • DISPLAY > Lens Setting • SYSTEM SETUP : Basic > Security Settings • SYSTEM SETUP : Advanced > Date and Time Setting 	
8	10-key pad	Use when entering the remote control ID.	
9	ID SET	Display the IDs for the projector and remote control on the screen.	
10	Remote control lock	Press and hold this button for four seconds to disable remote operation. Be sure to aim the remote at the remote receiver when performing this operation. This setting can only be adjusted using the remote control.	
11	SHUTTER (../menu/system_setup_advanced/#shutter_setting)	Temporarily suspend projection and mute audio. Press again to resume.	

Remote Control Reception Range

The reception ranges for the projector's three remote control receivers are as follows:

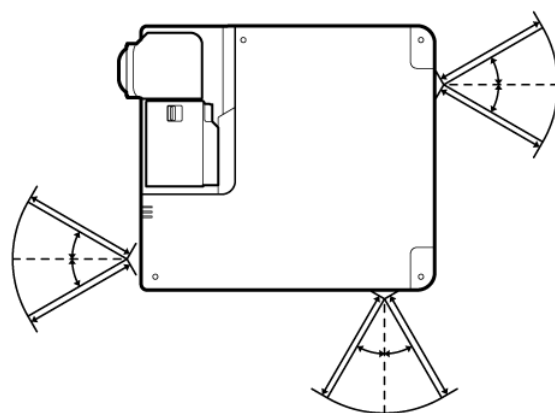

- **Angle:** ±30°
- **Distance:** Up to 8 m (26 ft)

Choosing IDs

IDs let you operate multiple projectors, either separately or together, using a single remote control.

Example: Setting the ID to "02"

This example sets the ID to "02".

1 Check the projector and remote control IDs.

Display the IDs by pressing the **ID SET** button on the remote control.



ID Set		
Projector ID	ID	Off
Remote	ID	01

Back Exit

2 Set the projector ID.

The projector ID defaults to "off".

- 1 Select **Projector ID Setting** in the **SYSTEM SETUP: Basic** menu.
- 2 Select **On** for **Projector ID Setting** in the ID selection display. Next, select "02" and press **ENTER**.

3 Set the remote control ID.

The remote control ID defaults to 01.

- 1 **Remote control:** Press and hold **ID SET** on the remote control for three seconds.
 - ➔ The remote control operation lamp will start to flash and the remote control will enter ID input mode. The lamp will continue to flash if the button is released. To return to ID input mode if the lamp stops flashing, indicating that ID input mode has ended, hold **ID SET** again for three seconds.
- 2 Press "0" "2" on the 10-key pad.
- 3 Press **ENTER**.
 - ➔ The remote control operation lamp will stop flashing.

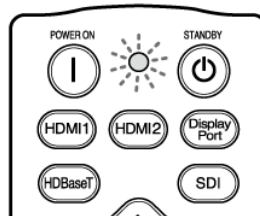

⚠ CAUTION

Once the operation is complete, check that the IDs on the projector and remote control are correct.

📄 TIP

- Projectors with IDs off can be controlled by remotes with any ID between "01" and "99".
- Pressing **ID SET** on the remote control displays the ID even if the projector and remote control IDs are not the same.

Basic Operation

Before installing the projector, master the basics of its operation as described below.

1 Rotate the lens.

The lens can be rotated and is equipped latches for the arm and projector head. Rotate the lens as described below. Be sure to latch the lens while projector is in use.

⚠ CAUTIONS

- Some portions of the projected image may not be visible depending on lens shift and the orientation of the lens.
- When rotated, the lens automatically returns to the previous shift position, causing the picture move. Do not rotate the lens while lens shift is in progress (i.e., while the image is moving).
- When rotating the lens, keep it supported and rotate it slowly.
- Pay attention to your surroundings when rotating the lens. Light from the product projected into the eyes could cause visual impairment.

◦ Rotating the Arm

When the arm latch is disengaged by pressing the arm latch release, the arm can be rotated 90°. Lift the latch release to latch the arm once more.

① Unlatch

② Latch

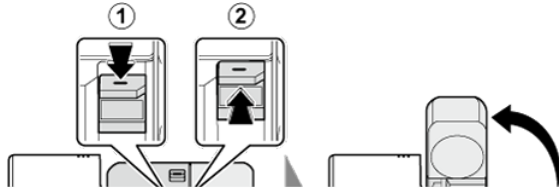

◦ Rotating the Projector Head

When the head latch is disengaged by sliding the head latch release to the **FREE** position, the projector head can be rotated 360° in 90° increments.

① FREE position

② LOCK position

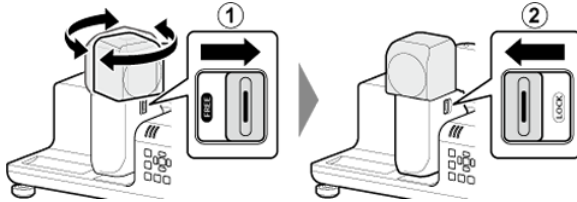

The lens can be rotated when the head latch release is in the FREE position and latches when the release is in the LOCK position.

⚠ CAUTION

Do not return the arm to the storage position with the lens facing down. Failure to observe this precaution could scratch or break the lens.

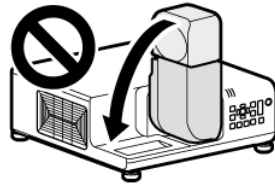

2 Attach the supplied power cord lock.

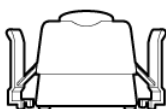

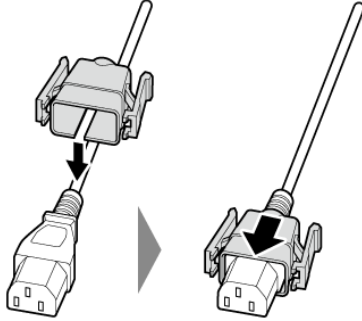

TIP: THE POWER CORD LOCK

To prevent the power cord being disconnected, secure it to the projector using the supplied power cord lock.

- 3** Connect the supplied power cord to the projector and plug it into a power outlet.

The cord is secure when you hear the tabs on the power cord lock click into place.

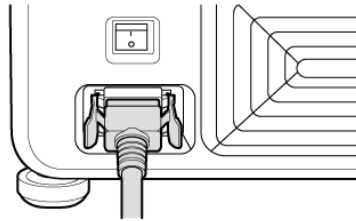

CAUTION

Use the supplied power cord only. In addition, note that supplied power cord is for use exclusively with this product. Do not use the power cord with any other device or the projector with any other power cord.

Power outlet

Use a three-pin socket.

- 4** Turn the power switch on.
The projector will switch to standby mode.
The indicator lamps will light or flash red.

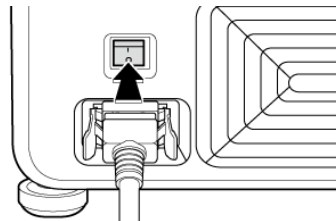

- 5** Press the power button to turn the projector on.
The indicator lamps will light green. Projection will start after a brief pause.

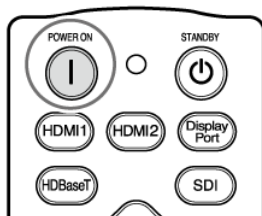

Remote control

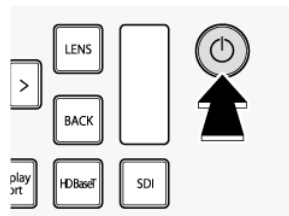

Projector

CAUTIONS

- Do not look directly into the lens while the projector is on.
- The projector automatically switches to standby about three seconds after the lens is returned to the storage position.

- 6** Adjust projector settings.

For more information, see ["Positioning and Focusing the Image" \(../../installation/adjust_projection_state\)](#).

Switching to Standby

Pressing the power button while the projector is on displays a confirmation dialog. Press the button again to switch the projector to standby. The cooling fan will turn off a few seconds later.

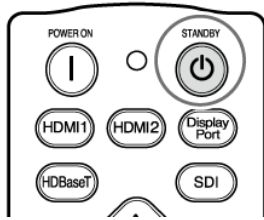

Remote control

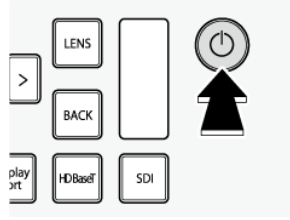

Projector

The projector automatically switches to standby about three seconds after the lens is returned to the storage position.

Warping (Geometric Correction) and Edge Blending

Project images onto curved or other irregular surfaces or create a single large picture from multiple component images using multiple projectors. Images are projected using the Warping and Blending Tool.

CAUTION

Warping (geometric correction) and edge blending are available with the FP-Z8000 only.

For more information, see " **Using the Warping and Blending Tool**"

([../warping_blending/overview_wab/index.html](#)).

Overview

- ▼ Spacing
- ▼ Height Adjustment
- ▼ Ceiling Mount Installation Precautions

Spacing

When installing the projector, choose a location where the vents will be a safe distance from walls or other obstructions. When installing units one above another, for example on shelves, leave a distance of no less than approximately 10 cm (0.33 ft) between the shelves and the wall.

- ① **Intake vent:** 40cm
- ② **Exhaust vent:** 40cm

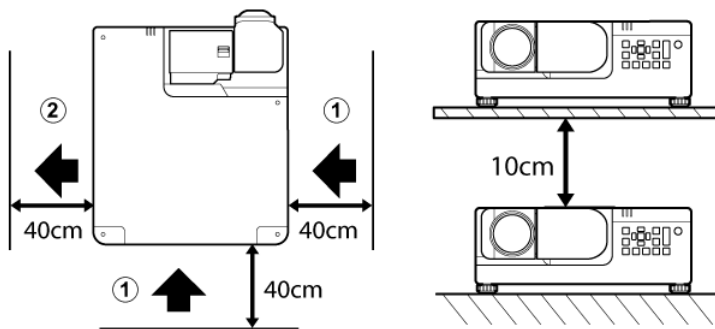

When installing two or more projectors side-by-side, leave a space of at least 80 cm (2.62 ft) between them. You will also need to ensure that the warm air from the exhaust vent does not enter any of the projectors' intake vents.

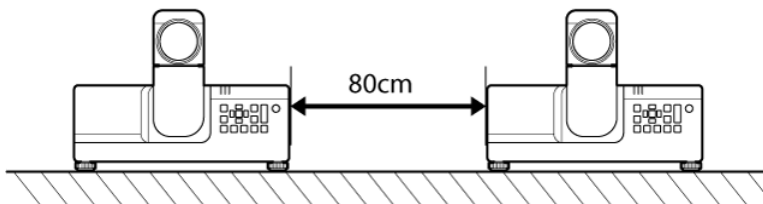

⚠ CAUTIONS

- Do not obstruct the vents. The build-up of heat inside the projector could cause fire.
- At high temperatures (over 35 °C (95 °F)), output will gradually drop until **Eco(60%)** is selected for **Light Source Mode**, after which any additional use will place the projector on standby. When the projector is turned on after having been allowed to cool, output will be restored to 100%.
- Output may drop at low temperatures, but will recover automatically as the temperature rises.

Height Adjustment

The height of the projector can be adjusted (by about 2.5 cm) using the adjustable feet. If desired, the feet can be removed and attached to the top of the projector. The projector ships with the feet attached to the bottom.

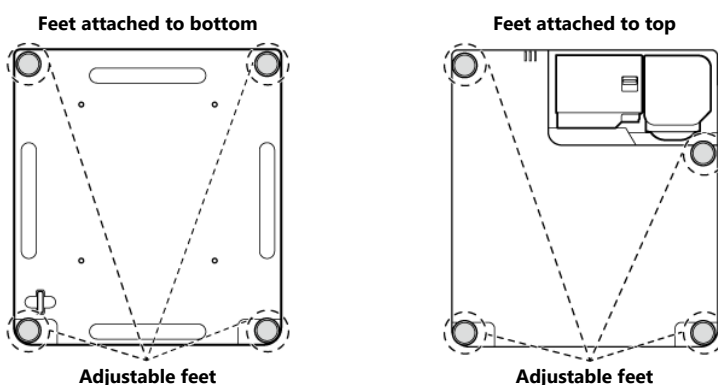

⚠ CAUTION: SWAPPING THE ADJUSTABLE FEET

To prevent the entry of dust, the projector comes with caps inserted in the attachment points for the adjustable feet on top of the projector. After swapping the feet from the top to the bottom or vice versa, be sure to insert the caps in the unused attachment points to prevent dust entering the projector.

Ceiling Mount Installation Precautions

- When suspending the projector from the ceiling, be sure to use the specified ceiling mount.
- When installing the projector, attach the drop-prevention kit included with the ceiling mount. Refer to your dealer if you require a drop-prevention kit.
- Ceiling installations should be performed only by qualified technicians.
- See the ceiling mount installation instructions for details.

Ceiling Mount Screw Specifications

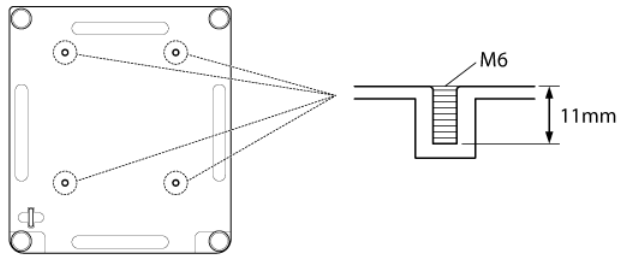

Bottom

Screw tightening torque: $4.0 \pm 0.5 \text{ N} \cdot \text{m}$

Positioning and Focusing the Image

The chief tools for positioning and focusing the projected image (lens shift, focus, and zoom) can be accessed via the **LENS** button on the control panel and the various lens option buttons on the remote control.



Remote control

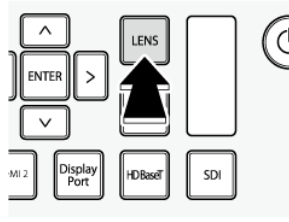

Projector

- ▼ Lens Shift
- ▼ Focus
- ▼ Zoom
- ▼ Positioning

Lens Shift

The position of the projected image can be adjusted using lens shift. Use Test Pattern 1.

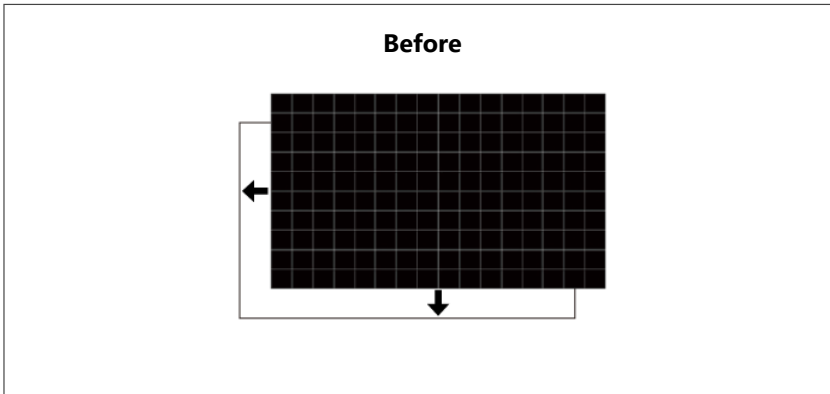

1 **Remote control:** Press the **SHIFT** button.

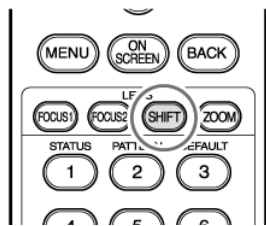

Remote control

Projector: Press the **LENS** button repeatedly until lens shift settings are displayed.

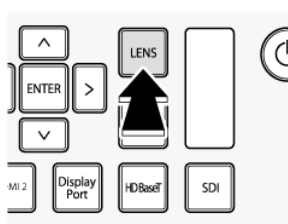

Projector

2 Position the projected image using the selector (up, down, left, and right).

TIP

The current shift position is displayed as a percentage.

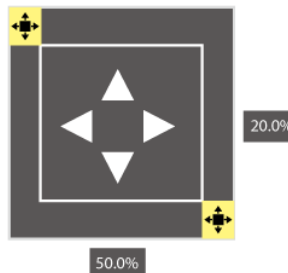

3 Press **BACK** to exit.

TIPS

- Lens shift can also be adjusted from the menus.
- The selected shift position is stored when the lens is rotated.
- When you latch the lens after rotating it to a new position, the previously-selected shift position will be recalled automatically.
- Holding the **SHIFT** button for three seconds displays a confirmation dialog where the lens can be restored to the home position.

Focus

The sharpness of the projected image can be adjusted by focusing the projector. Use Test Pattern 1 when focusing.

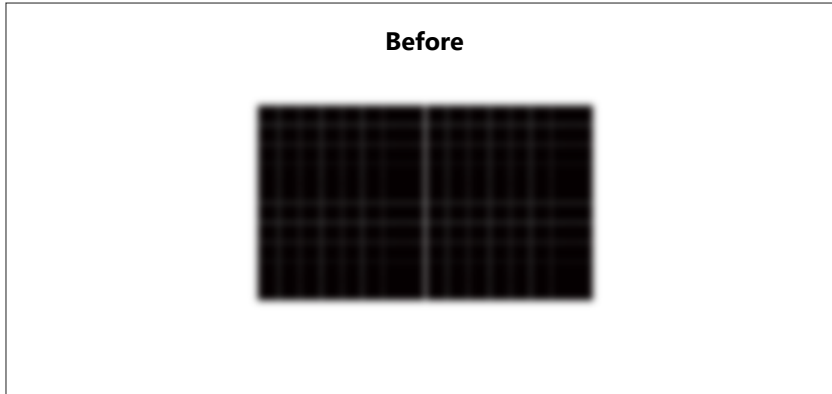

1 **Remote control:** Use the **"FOCUS1"** and **"FOCUS2"** buttons on the remote control.

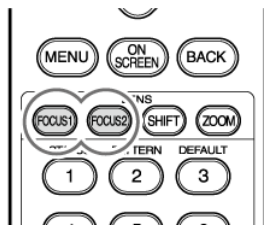

Remote control

Projector: Press the **LENS** button repeatedly until focus settings are displayed.

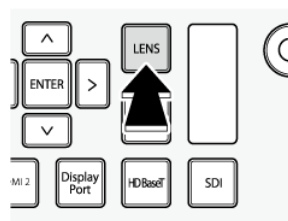

Projector

2 Press the selector left or right to focus.
The selected focus setting (1 or 2) is identified by an icon.



3 Press **BACK** to exit when the operation is complete.

TIP

Focus can also be adjusted from the menus.

Adjusting Focus

Focus can be adjusted using the **FOCUS1** and **FOCUS2** buttons on the remote control.

- **FOCUS1**: Adjust overall focus.
- **FOCUS2**: Adjust focus at the edges of the picture.

To adjust focus, display Test Pattern 1 and follow the steps below.

1. Adjust overall focus using the **FOCUS1** button (①).
Adjust focus for the portion of the screen *closest to the lens*.
2. Adjust focus at the edges using the **FOCUS2** button (②).
Adjust focus for the portion of the screen *farthest from the lens*.
3. Repeat Step ① to adjust overall focus using the **FOCUS1** button.
4. If the picture is not in focus, repeat Steps 1 through 3.

■ Checking Focus

Home lens shift position

Lens shifted vertically

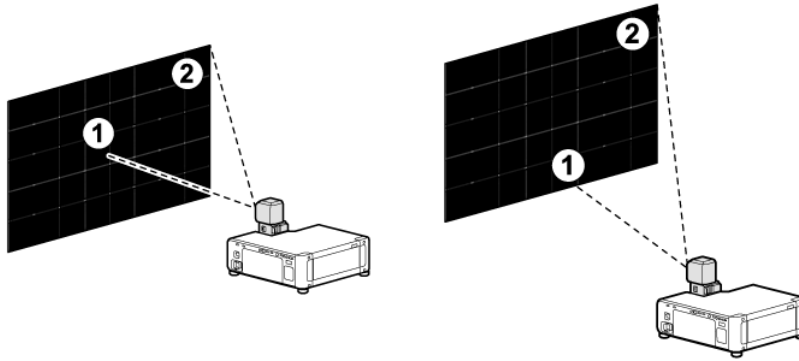

Zoom

The size of the projected image can be adjusted using zoom.

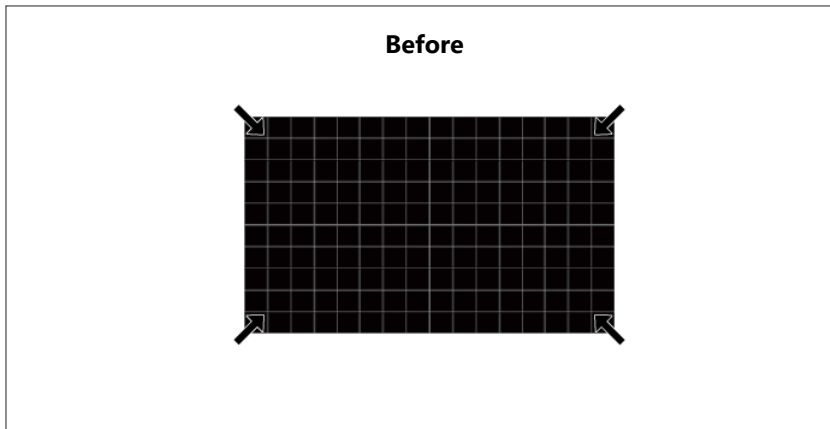

1 **Remote control**: Press the **ZOOM** button.

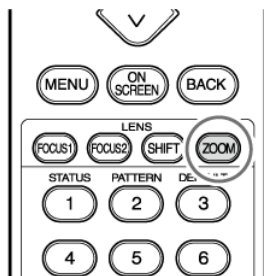

Remote control

Projector: Press the **LENS** button repeatedly until zoom settings are displayed.

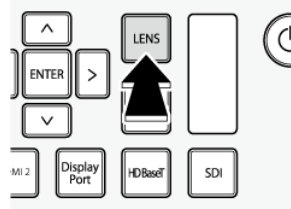

Projector

2 Press the selector left or right to adjust the size of the projected image.

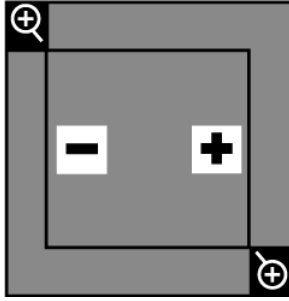

3 Press **BACK** to exit.

TIPS

- Zoom can also be adjusted from the menus.
- You may need to refocus after adjusting zoom.

Positioning

Choose an option according to the location of the projector and screen.

Select **Front Table**, **Rear Table**, **Front Ceiling**, or **Rear Ceiling** for **Projector Position** in the **DISPLAY** menu (← **Projector Position** (../menu/display/index.html#projector_position)).

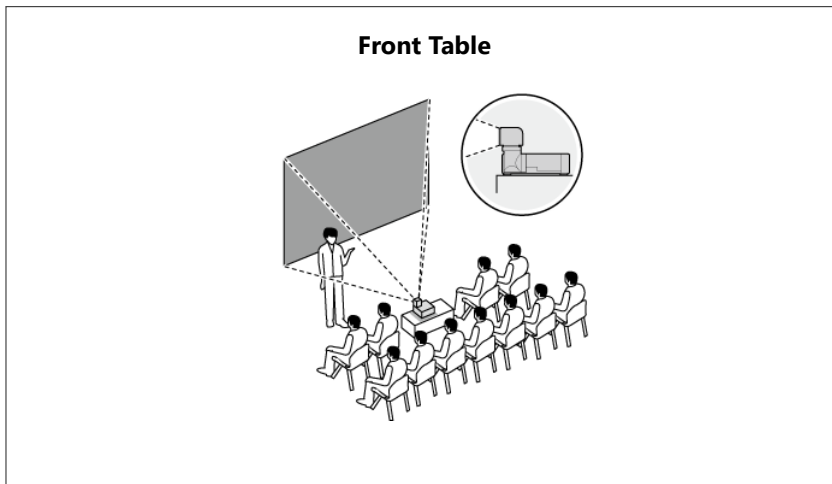

Connections

▼ Connecting Third-Party Video Transmitters

▼ PLink

Connecting Third-Party Video Transmitters

Third-party video transmitters that support HDBaseT can be connected via the projector's HDBaseT connector.



Connection Schematic

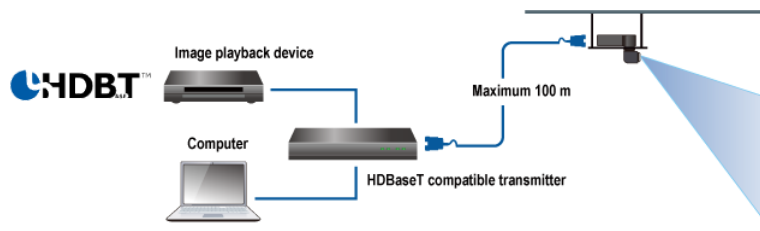

⚠ CAUTIONS

- Use an STP LAN cable with category 5e shielding or better.
- The maximum distance that video can be transmitted over a LAN cable is 100 m (328 ft).
- Operation is not guaranteed with all HDBaseT-compatible devices or in all operating environments.
- The projector cannot be connected directly to networks operated by mobile communications service providers, fixed-network communications service providers, Internet service providers, or other telecommunications carriers. Any connection to the Internet must be made via a router.

PJLink

The projector conforms to JBMIA PJLink Class 2 standard.

- The port for the PJLink search function is 4352 (UDP).
- The network must be configured appropriately before PJLink can be used.
- PJLink specifications are available here.
<https://pjlink.jbmia.or.jp/english/> (<https://pjlink.jbmia.or.jp/english/>)

🗨 TIPS

- PJLink support is available with LAN controls.
- For information on supported PJLink commands, see [👉 "PJLink Commands" \(../technical_notes/pjlink/index.html\)](#).

Menu List

The projector menus are organized as shown below.

- ▼ DISPLAY
- ▼ PICTURE
- ▼ SOURCE
- ▼ SYSTEM SETUP : Basic
- ▼ SYSTEM SETUP : Advanced

DISPLAY

Item	Options (defaults in bold)
Lens Setting	Lens shift: —
	Lens shift settings: Shift area (Limited / Full) / Auto lens shift (On / Off) / Home Position
	FOCUS 1: —
	FOCUS 2: —
	Zoom: —
Test Pattern	Off / 1 / 2 / 3 / 4 / 5 / 6 / 7 / 8 / 9 / 11 / 12 / 13
Projector Position	Front Table / Rear Table / Rear Ceiling / Front Ceiling
Aspect Ratio	Auto / Real / 4:3 / 16:10 / 16:9
Keystone	Axis - Vertical (V): -60 – 0 – 60
	Axis - Horizontal (H): -60 – 0 – 60
Corner Fit	V (Vertical): 0 – 60
	H (Horizontal): 0 – 60
Blanking	Upper (0 – 300), Lower (0 – 300), Left (0 – 500), Right (0 – 500)
Digital Zoom	1.0 – 2.0
Raster Position	With a 16 : 9 input signal: Upper (0 – 60), Lower (0 – 60)
Lens Rotation setting	—

PICTURE

Item	Options (defaults in bold)
Picture Mode	Bright / Standard / sRGB / DICOM SIM
Brightness	0 – 50 – 100
Contrast	-50 – 0 – 50
Tint	-45 – 0 – 45
Color	-50 – 0 – 50
Gamma	1.6 – 2.2 – 3.3
Sharpness	0 – 15 – 31
Color Temperature	3200K – 7100K – 9300K
Color Temperature Fine Tuning	R / G / B Gain: 0 – 100 – 200
	R / G / B Offset: -50 – 0 – 50

Item	Options (defaults in bold)
7colors Tuning	R, G, B, C, M, or Y Selected for Color <ul style="list-style-type: none"> Hue: -99 – 0 – 99 Gain: 0 – 50 – 100 Saturation: -50 – 0 – 50
	W Selected for Color <ul style="list-style-type: none"> R Gain: 0 – 50 – 100 G Gain: 0 – 50 – 100 B Gain: 0 – 50 – 100

SOURCE

Item	Options (defaults in bold)
Quick Auto Search	On / Off
INPUT	HDMI1 / HDMI2 / DisplayPort / HDBaseT / SDI
HDMI Range	Auto / Full / Limited
Color Space Conversion	Auto / RGB / YUV
HDMI Equalizer	Auto / lower / low / middle / high / higher

SYSTEM SETUP : Basic

Item	Options (defaults in bold)
Language	18 languages
Menu Settings	Menu display time: Always / 30 sec / 20 sec / 10 sec / 5 sec
	Menu position: Center / Bottom-Left / Bottom-Right / Top-Left / Top-Right
	Reminder Message: On / Off
Background Color	FUJIFILM(Blue) / FUJIFILM(White) / FUJIFILM(Black) / Black / Blue
Remote Receiver	All / Front+Side / Rear+Side / Side
Panel Key Lock	On / Off
Projector ID Setting	01 – 99 / Off
Security Settings	Power on Lock: On / Off
Audio Settings	Mute: On / Off
	Volume: 0 – 5 – 10
	source (FP-Z8000 only): On / Off
High Altitude Mode	On / Off
Reset Settings	—

SYSTEM SETUP : Advanced

Item	Options (defaults in bold)
Light Source Mode	Normal / Eco(60%)
Light Output Setting	20 – 100
Light Source Information	—
Shutter Setting	Fade-in: Off / 0.6s / 1.0s / 2.0s / 3.0s / 4.0s / 5.0s / 7.0s / 10.0s
	Fade-out: Off / 0.6s / 1.0s / 2.0s / 3.0s / 4.0s / 5.0s / 7.0s / 10.0s

Item	Options (defaults in bold)
	Dynamic Black: On / Off
	Dynamic Contrast Ratio: On / Off
Operation Settings	Direct Power On: On / Off
	Auto Power Off: Disable / 3 min / 10 min / 15 min / 20 min / 25 min / 30 min
	Fade-Out timer: Disable / 5 min / 10 min / 15 min / 20 min / 25 min / 30 min
	Sleep Timer : Disable / 30 min / 1 hr / 2 hr / 3 hr / 4 hr / 8 hr / 12 hr
Date and Time Setting	Date / Time
Schedule Setting	On / Off
Control Channel	LAN · RS-232C / HDBaseT
Standby Settings	Enable Network Standby Mode: On / Off
	Switch to Normal Standby Mode: Off / 20 min / 1 hr / 3 hr / 6 hr
LAN Settings	AMX Device Discovery: On / Off
	DHCP: On / Off

Using the Menus

To view the menu, press the **MENU** button on the control panel or remote control.

- 1 Press the **MENU** button on the control panel or remote control. The menu will be displayed.

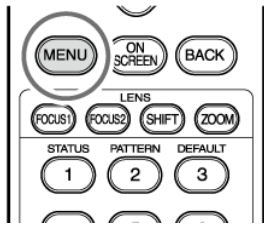

Remote control

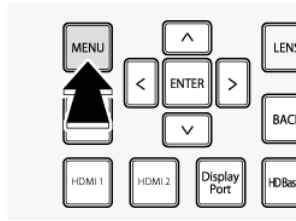

Projector

- 2 Press the selector left or right to choose a menu.



- 3 Press the selector up or down to highlight items.

- 4 Press the selector left or right to choose the desired option.

TIP

If "**ENTER**" is displayed when a menu item is highlighted, pressing **ENTER** will display a sub-menu where the selection can be made.

- 5 Press **BACK** to save changes and exit.

DISPLAY

Adjust projector display settings.

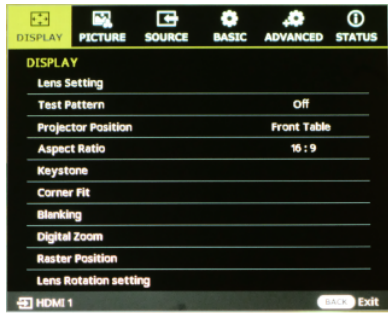

- ▼ Lens Setting
- ▼ Test Pattern
- ▼ Projector Position
- ▼ Aspect Ratio
- ▼ Keystone
- ▼ Corner Fit
- ▼ Blanking
- ▼ Digital Zoom
- ▼ Raster Position
- ▼ Lens Rotation setting

Lens Setting

Adjust lens-related settings.

Highlight the desired lens setting and press **ENTER** to display options.

Lens Setting	Description
Lens shift	Position the projected image using lens shift.
Lens shift settings	Adjust lens shift settings.
FOCUS 1	Adjust focus for the entire image.
FOCUS 2	Adjust focus at the edges of the image.
Zoom	Adjust the size of the projected image.

Lens shift

Press **ENTER** to display the lens shift dialog and use the selector (up, down, left, and right) to position the image.

The image can be shifted vertically (V) by up to 70% and horizontally (H) by up to 35%.

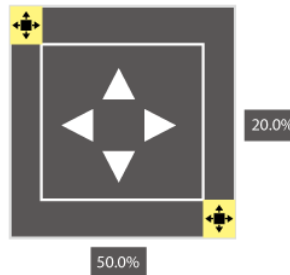

TIPS

- The current shift position is displayed as a percentage.
- If you keep the lens shift button pressed, shift will pause at a point close to the maximum. Press the button again to further increase shift.

Lens shift settings

Adjust lens shift options.

Press **ENTER** to display options and then select the desired item.

■ Shift area

Choose how much the lens can be shifted.

Options	
Limited	Full

- **Limited:** Lens shift is restricted, preventing any portion of the image being eclipsed.

- ① Lens centered
- ② Image shifted down and to the left: entire image visible

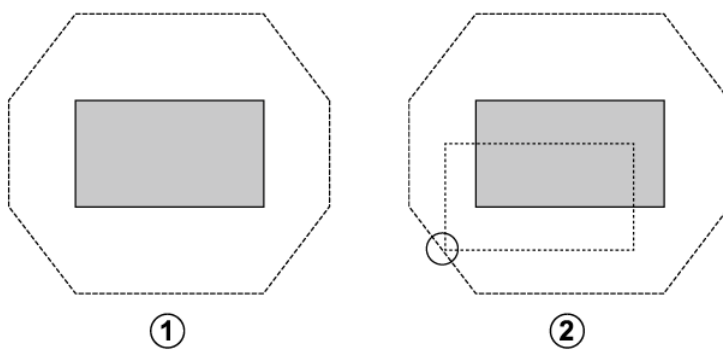

- **Full:** The lens can be shifted throughout its range.

- ① Lens centered
- ② Image shifted down and to the left: bottom left corner of image not visible

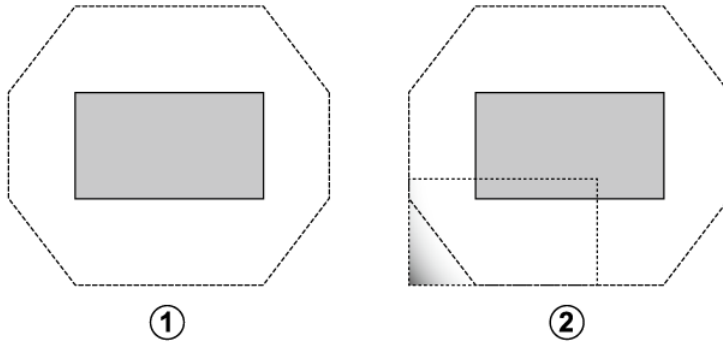

■ Auto lens shift

Choose whether lens shift is adjusted automatically.

Option	Description
On	The last-selected shift position will automatically be restored when you rotate the lens.
Off	Auto lens shift disabled.

⚠ CAUTION

Shift starts once the lens has been rotated and locked. Do not rotate the lens while shift is in progress, as otherwise the product could malfunction.

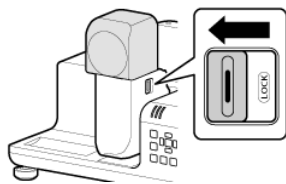

■ Home Position

Return the lens to the home position.

Pressing **ENTER** displays a prompt asking whether you wish to return the lens to the home shift position.

Press **OK** to start lens shift. Do not perform any other operations until the projector displays a message stating that reset is complete.

📄 TIP

The lens can also be returned to the home position by holding the **SHIFT** button on the remote control for over three seconds.

🔍 FOCUS 1 / 🔍 FOCUS 2

Adjust focus.

Press **ENTER** to display the focus dialog and use the selector (left or right) to adjust focus

⏪ Adjusting Focus

(././installation/adjust_projection_state/index.html#focus_adjustment).

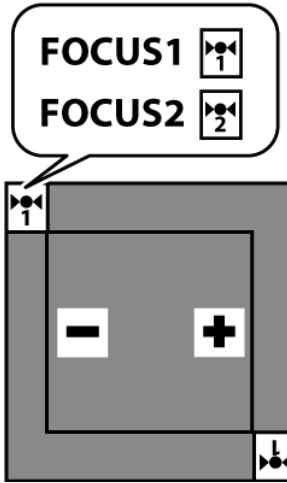

Zoom

Adjust the size of the projected image.

Press **ENTER** to display the zoom dialog and use the selector (up, down, left, and right) to adjust the size of the projected image.

Select “-” to make the image smaller, “+” to make it larger.

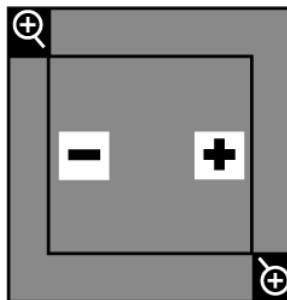

Test Pattern

Choose a grid or other test pattern for display during installation.

Options													
Off	1	2	3	4	5	6	7	8	9	10	11	12	13

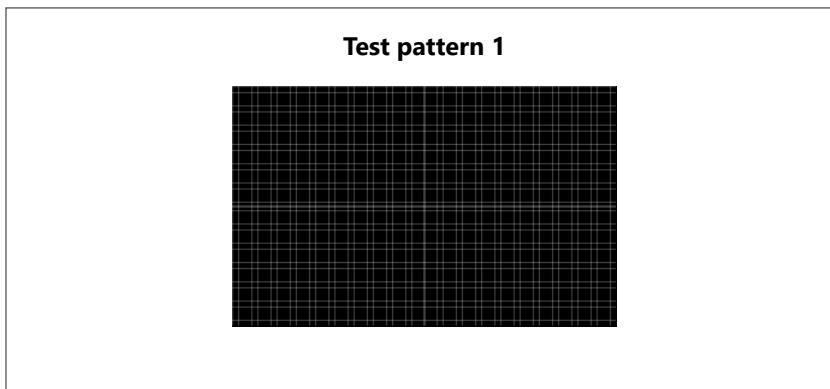

TIP

To turn the test pattern off, select **Off** in the menu or repeatedly press the **PATTERN** button on the remote control until the pattern is no longer displayed.

Projector Position

Position the beam according to the projector's location.

Options			
Front Table	Rear Table	Rear Ceiling	Front Ceiling

- **Front Table:** Choose if the projector is on a table in front of the screen.

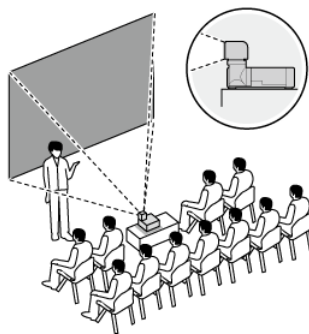

- **Rear Table:** Choose if the projector is on a table behind the screen.

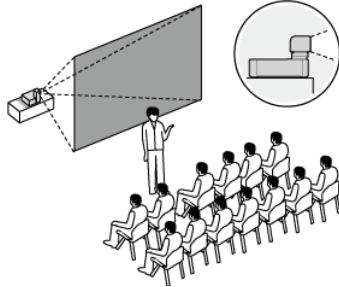

- **Rear Ceiling:** Choose if the projector is suspended from the ceiling behind the screen.

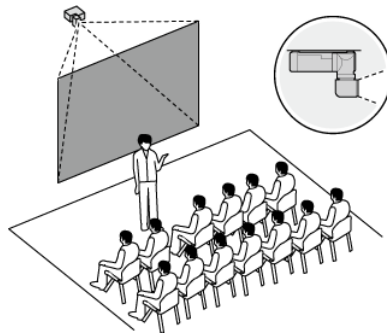

- **Front Ceiling:** Choose if the projector is suspended from the ceiling in front of the screen.

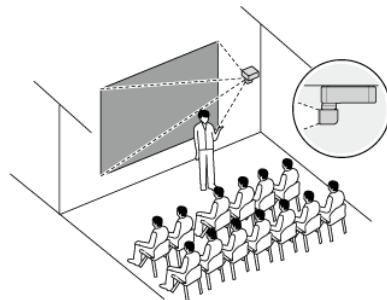

Aspect Ratio

Choose the aspect ratio of the projected image.

Options				
Auto	Real	4:3	16:10	16:9

TIP

The setting for each input is stored separately.

Keystone

Use keystone compensation to correct "keystone" and make the sides of the projected image parallel the edges of the screen.

Press **ENTER** to display the keystone compensation dialog and use the selector (up, down, left, and right) to correct keystone distortion.

Negative values reduce the size of the projected image while positive values increase it.



Axis	Range
Vertical (V)	-60 — 60
Horizontal (H)	-60 — 60

Corner Fit

Position the corners of the projected image to correct distortion.

1 Press **ENTER** to display corner fit settings.

2 Highlight a corner using the selector (up, down, left, and right) and press **ENTER**.

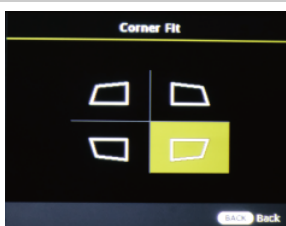

3 Position the corner horizontally and vertically.



Axis	Range
Vertical (V)	0 — 60
Horizontal (H)	0 — 60

4 Press **ENTER** to save changes and exit.

Blanking

The screen margins can be adjusted vertically by 300 pixels and horizontally 500 pixels. The maximum amount for either the left or right margin is 500 pixels, but the maximum for both margins combined is 960 pixels.

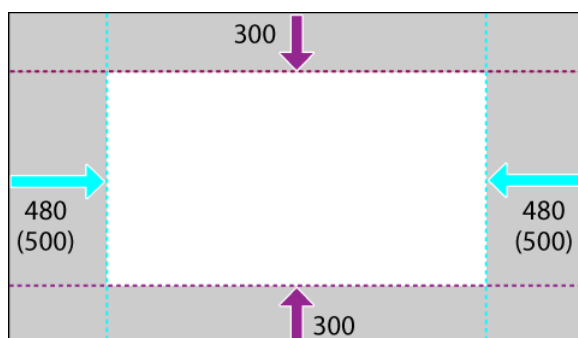

Options and ranges			
Upper 300 pixels	Lower 300 pixels	Left 500 pixels	Right 500 pixels

Press the selector up or down to highlight the desired margin and press left or right to adjust.

TIP

You may not be able to adjust the left and right margins at some aspect ratios.

Digital Zoom

Zoom the projected image in using digital zoom.

Highlight **Digital Zoom** in the **DISPLAY** menu and press **ENTER** to display a digital zoom window at the bottom right corner of the screen.

Press the selector up or down to choose the magnification (maximum 2×).

Options
1.0 — 2.0

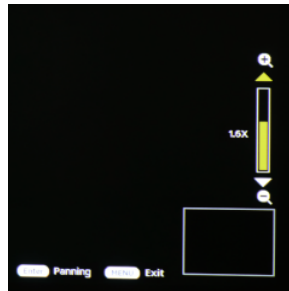

Press **ENTER** in the digital zoom display and press the selector up, down, left, or right to scroll the zoom display.



Raster Position

Input images that do not fill the display can be positioned as desired within the screen.

Image with an aspect ratio of 16:9 displayed on a screen with an aspect ratio of 16:10

- ① Display area aspect ratio: 16:10
- ② Image aspect ratio: 16:9
- ③ Projected image can be moved 60 pixels up or down

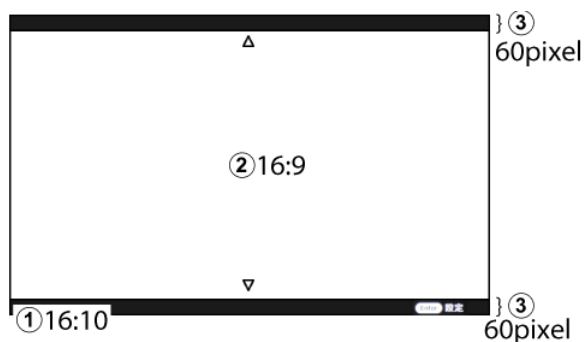

TIP

To return the projected image to its original position, press the **DEFAULT** button on the remote control during adjustment.

Lens Rotation setting

Adjust lens rotation settings.

Highlight a lens rotation item and press **ENTER** to view options.

Project on Rotating

Choose whether the projector lamp remains on while the lens is rotated.

Option	Description
On	The lamp remains on while the lens is rotated.
Off	The lamp turns off while the lens is rotated.

Image Rotation

Choose whether the projector automatically rotates images to match lens rotation.

Option	Description
Auto	The projector detects lens rotation and rotates images to match.
Off	Automatic image rotation disabled.

Upside on Vertical Image

Choose the side on which the top of portrait-orientation pictures appears when **Auto** is selected for **Image Rotation**.

Option	Description
L-SIDE	Pictures are rotated so that the top is on the left.
R-SIDE	Pictures are rotated so that the top is on the right.

TIP

The setting takes effect only after the lens has been rotated and locked. It has no effect until the lens is locked.

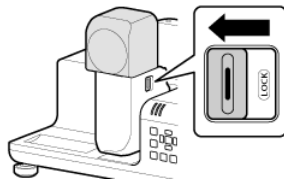

PICTURE

Adjust settings for the projected image.



- ▼ Picture Mode
- ▼ Brightness
- ▼ Contrast
- ▼ Tint
- ▼ Color
- ▼ Gamma
- ▼ Sharpness
- ▼ Color Temperature
- ▼ Color Temperature Fine Tuning
- ▼ 7colors Tuning

Picture Mode

Choose a picture mode.

Option	Description
Bright	For use in bright locations.
Standard	Choose for vivid colors.
sRGB	Colors are displayed using the sRGB color space.
DICOM SIM	DICOM simulation mode. Choose for clearer reproduction of medical images such as X-rays or MRIs.

TIP

Note that the projector is not a medical device. Do not use for consultations.

Brightness

Adjust the brightness of the projected image.

Options
0 — 50 — 100

Contrast

Adjust contrast.

Options
-50 — 0 — 50

Tint

Adjust colors in the projected image. The higher the value, the greener the image, the lower the value, the redder the image.

Options
-45 — 0 — 45

TIP

This option is available with **YUV** (but not **RGB**) input.

Color

Adjust saturation. Positive values make colors more saturated (vivid), while negative values reduce saturation.

Options
-50 — 0 — 50

TIP

This option is available with **YUV** (but not **RGB**) input.

Gamma

Choose a gamma value for the projected image.

Options
1.6 — 2.2 — 3.3

Sharpness

Adjust the sharpness of outlines.

Options
0 — 15 — 31

Color Temperature

Choose the color temperature of the projected image.

Press **ENTER** to display color temperature options and choose a color temperature.

Options
3200K — 7100K — 9300K

TIP

The default value varies with the option selected for **Picture Mode**.

- **Bright:** 7100K
- **Standard:** 7300K
- **sRGB:** 6500K
- **DICOM SIM:** Color temperature selection not available.

Color Temperature Fine Tuning

Fine-tune color temperature.

After pressing **ENTER** to display advanced color temperature options, press the selector up or down to highlight options and left or right to adjust.

Option	Description
R Gain	Adjust the contrast of reds. Choose from values between 0 and 200 . The lower the value, the lower the contrast; the higher the value, the higher the contrast.
G Gain	Adjust the contrast of greens. Choose from values between 0 and 200 . The lower the value, the lower the contrast; the higher the value, the higher the contrast.
B Gain	Adjust the contrast of blues. Choose from values between 0 and 200 . The lower the value, the lower the contrast; the higher the value, the higher the contrast.

Option	Description
R Offset	Adjust the brightness of reds. Choose from values between -50 and 50 . Lower values reduce brightness, while higher values increase it.
G Offset	Adjust the brightness of greens. Choose from values between -50 and 50 . Lower values reduce brightness, while higher values increase it.
B Offset	Adjust the brightness of blues. Choose from values between -50 and 50 . Lower values reduce brightness, while higher values increase it.

7colors Tuning

Adjust hue, gain, and saturation for each of seven color channels (R, G, B, C, M, Y, and W).

After pressing **ENTER** to display options, press the selector left and right to highlight the desired color channel and adjust each parameter as desired, starting with **Color**.

R, G, B, C, M, or Y Selected for Color

Option	Description
Hue	-99 — 0 — 99
Gain	0 — 50 — 100
Saturation	-50 — 0 — 50

W Selected for Color

Option	Description
R Gain	0 — 50 — 100
G Gain	0 — 50 — 100
B Gain	0 — 50 — 100

SOURCE

Adjust input source settings.

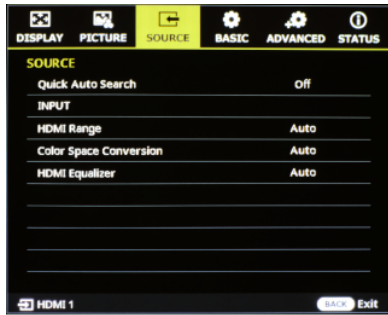

- ▼ Quick Auto Search
- ▼ INPUT
- ▼ HDMI Range
- ▼ Color Space Conversion
- ▼ HDMI Equalizer

Quick Auto Search

Enable or disable automatic input source detection.

Option	Description
On	Enable automatic input source detection.
Off	Disable automatic input source detection.

INPUT

Choose an input source.

Options				
HDMI1	HDMI2	DisplayPort	HDBaseT	SDI

📄 "HDMI2" (Warping and Blending Tool Available with FP-Z8000 Only)

- **HDMI2** is available with the FP-Z8000 only.
- Automatic source detection is not available with **HDMI2**, which is used by the Warping and Blending Tool.
- The default resolution is WUXGA (1920 × 1200).
- Other resolutions can be selected using the Warping and Blending Tool.

👉 [Using the Warping and Blending Tool \(../warping_blending/overview_wab/index.html\)](#)

HDMI Range

Choose the HDMI range.

Option	Description
Auto	The projector automatically selects Full or Limited according to the source.
Full	Choose for RGB output in the range of 0 to 255 to prevent shadows that are overly bright or "washed out".
Limited	Limit RGB output to values between 16 and 235 to prevent loss of detail in shadows.

Color Space Conversion

Choose the color space in which images are displayed.

Option	Description
Auto	The projector automatically chooses an output color space from RGB and YUV .

Option	Description
RGB	Images are displayed in the RGB color space.
YUV	Images are displayed in the YUV color space.

 **CAUTION**

Regardless of the option selected, color space conversion resets to **Auto** when the projector is turned off.

HDMI Equalizer

Adjust the HDMI signal for more reliable output over long cables. Choose an option adapted to the operating environment.

Options					
Auto	lower	low	middle	high	higer

SYSTEM SETUP : Basic

Adjust basic system settings.



- ▼ Language
- ▼ Menu Settings
- ▼ Background Color
- ▼ Remote Receiver
- ▼ Panel Key Lock
- ▼ Projector ID Setting
- ▼ Security Settings
- ▼ Audio Settings
- ▼ High Altitude Mode
- ▼ Reset Settings

Language

Choose the language in which menus and messages are displayed.

Options		
English	繁體中文	Čeština
Français	简体中文	Português
Deutsch	日本語	Magyar
Italiano	한국어	Nederlands
Español	Svenska	Dansk
Русский	Türkçe	Polski

Menu Settings

Adjust menu display settings.

Press **ENTER** to display options and then select the desired item.

Options		
Menu display time	Menu position	Reminder Message

Menu display time

Choose how the menus are displayed.

Options				
Always	5 sec	10 sec	20 sec	30 sec

TIP

Select **Always** to display the menus indefinitely.

Menu position

Choose where the menus are displayed.

Options				
Center	Top-Left	Top-Right	Bottom-Right	Bottom-Left

Reminder Message

Select **On** to display alerts.

Options	
On	Off

⚠ CAUTION

Selecting **Off** for **Reminder Message** disables the display of alarm alert messages.



Background Color

Choose the menu background color.

Options				
FUJIFILM(Blue)	FUJIFILM(White)	FUJIFILM(Black)	Black	Blue

Remote Receiver

Choose the IR receivers used by the remote control.

- ① Front
- ② Side
- ③ Rear

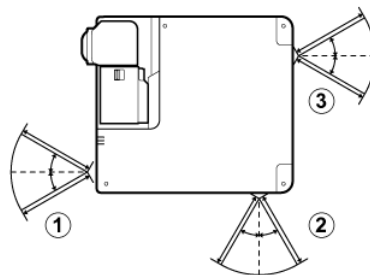

Options			
All	Front+Side	Rear+Side	Side

📖 TIP

Select **All** to enable all three receivers (front, back, and side).

Panel Key Lock

Lock the controls on the body of the projector.

Options	
On	Off

📖 TIPS

- Selecting **On** displays a confirmation dialog; choose **Yes** to lock the buttons on the projector control panel.
- To release the control-panel lock, press the selector right for three seconds.

Projector ID Setting

Choose an ID for each projector.

Option	Description
Off	Turn the projector ID off. The projector can be controlled by from any remote, regardless of its ID.
On	Choose the projector ID. You will need to set the remote control to the same ID (👉 Choosing IDs (../about_this_product/remote_control/#id_set)).

Follow the steps below.

- 1 Highlight **Projector ID Setting** in the **SYSTEM SETUP : Basic** menu and press **ENTER** to view ID selection options.

- 2 Select **On** for **Projector ID Setting**.

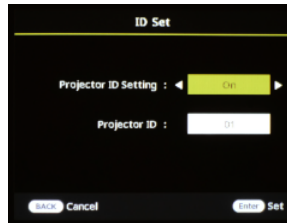

- 3 Enter a value between "01" and "99" for **Projector ID** and select **ENTER**.

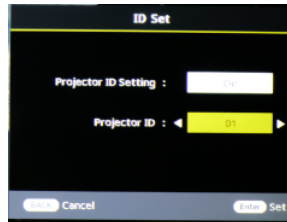

- 4 Select **Yes** when prompted. A second confirmation dialog will be displayed; highlight **OK** and press **ENTER** to confirm the projector ID.

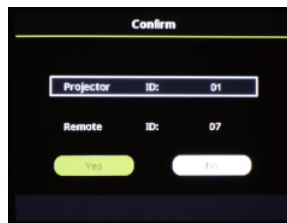

⚠ CAUTION

After choosing a projector ID, check the IDs for the projector and remote control and confirm that they have been updated.

📖 TIP

- This item cannot be used to change the remote control ID (👉 **Choosing IDs** ([../about_this_product/remote_control/#id_set](#))).
- Projectors with IDs off can be controlled by remotes with any ID between "01" and "99".

Security Settings

Adjust security settings.

Press **ENTER** to display options and then select the desired item.

Change password

Press **ENTER** and change the password.

Choose a password of six characters containing any combination of the numbers 1 through 4.

Press the selector up for 1, right for 2, down for 3, or left for 4.

After confirming the password by entering it a second time, press **ENTER** to proceed. You must supply the password when turning the projector on with **On** selected for **Power on Lock**.

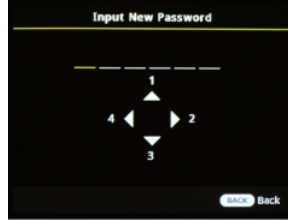

⚠ CAUTION

Failure to provide the correct password will prevent the projector being used or initialized. Be careful not to lose the password. Consult with staff at the point of purchase should the password be lost.

Power on Lock

Selecting **On** requires users to enter the password chosen using **Change password** whenever the projector is turned on.

Options	
On	Off

📖 TIP

After choosing **On**, you will be prompted to enter the password. Enter the password to proceed.

Audio Settings

Adjust audio settings.

Press **ENTER** to display options and then select the desired item.

Mute

Select **On** to mute audio.

Options	
On	Off

Volume

Adjust volume.

Options
0 — 5 — 10

Source (FP-Z6000 only)

Switch between AUDIO inputs. Selecting **On** disables input from sources not connected to the AUDIO terminal.

Options	
On	Off

High Altitude Mode

When using the product at high altitudes (above 1,500 m/4,900 ft), select **On** for **High Altitude Mode** to ensure that the product's internal temperature-control mechanism functions correctly. Failure to observe this precaution could shorten the life of the product's parts.

Options	
On	Off

TIP

Selecting **On** displays a confirmation dialog; choose **Yes** to enable high-altitude mode. The fan will operate at higher speeds.

Reset Settings

Restore all items in a selected menu to their default values.

Press **ENTER** and choose the menu to be reset.

Option	Description
Display Setting	Reset the items in the DISPLAY menu to default values.
Picture Setting	Reset the items in the PICTURE menu to default values.
Set Up BASIC Setting	Reset the items in the SYSTEM SETUP : Basic menu to default values.
Set Up ADVANCED Setting	Reset the items in the SYSTEM SETUP : Advanced menu to default values.
Initialize	Reset the items in all menus (DISPLAY , PICTURE , SYSTEM SETUP : Basic , and SYSTEM SETUP : Advanced) to their default values. The following items are not reset. <ul style="list-style-type: none">• DISPLAY > Lens Setting• SYSTEM SETUP : Basic > Security Settings• SYSTEM SETUP : Advanced > Date and Time Setting

TIP

Highlighting a menu and pressing **ENTER** displays a confirmation dialog; select **OK** to restore the items in the selected menu to their default values.

SYSTEM SETUP : Advanced

Adjust advanced system settings.



- ▼ Light Source Mode
- ▼ Light Output Setting
- ▼ Light Source Information
- ▼ Shutter Setting
- ▼ Operation Settings
- ▼ Date and Time Setting
- ▼ Schedule Setting
- ▼ Control Channel
- ▼ Standby Settings
- ▼ LAN Settings

Light Source Mode

Choose a light-source brightness mode.

Options	
Normal	Eco(60%)

Light Output Setting

Adjust the brightness of the light source. Choose from values of from 20 to 100 in increments of 10. This option is available only when **Bright** is selected for **Picture Mode** in the **PICTURE** menu. When **Eco(60%)** is selected for **Light Source Mode** in the **SYSTEM SETUP : Advanced** menu, brightness is fixed at 60%.

Light Source Information

View information about the light source.

Press **ENTER** to view information about the light source.

Option	Description
Light Source Usage Total Time	The total length of time the light source has been on in Normal and Eco(60%) modes.
Normal	The length of time the light source has been on with Normal selected for Light Source Mode .
Eco(60%)	The length of time the light source has been on with Eco(60%) selected for Light Source Mode .

Shutter Setting

Adjust projector shutter settings.

Pressing **ENTER** displays a sub-menu containing the items listed below.

Fade-in

Choose how long the picture takes to fade in after the shutter button is pressed to resume projection.

Options								
Off	0.6s	1.0s	2.0s	3.0s	4.0s	5.0s	7.0s	10.0s

CAUTION

Fade-in is enabled only after projection has been suspended (i.e., the projector has been in the SHUTTER state, with image and sound output suspended) for at least three minutes. The picture will not fade in if projection is resumed earlier.

Fade-out

Choose how long the picture takes to fade out when the shutter button is pressed to suspend projection.

Options								
Off	0.6s	1.0s	2.0s	3.0s	4.0s	5.0s	7.0s	10.0s

Dynamic Black

Choose whether the projector detects when a solid black image is displayed and automatically reduces output by 70%. The projector automatically restores output to 100% when an image that is not solid black is displayed.

Options	
On	Off

TIP

Selecting **On** overrides the option selected for **Light Source Mode**.

Dynamic Contrast Ratio

If **On** is selected, the projector will detect when a solid black image is displayed and automatically suspend output. Dynamic black will be given priority if **On** is selected for **Dynamic Black**.

Options	
On	Off

Operation Settings

Set timers and the like.

Press **ENTER** to display options and then select the desired item.

Direct Power On

If **On** is selected, the projector will turn on automatically (i.e., without your pressing the power button) if the main power switch is on when power is supplied.

Options	
On	Off

Auto Power Off

Choose the length of time before the projector automatically enters standby.

Options						
Disable	3 min	10 min	15 min	20 min	25 min	30 min

Fade-Out timer

Choose how long it takes in the absence of an input signal for output to resume after the shutter button is pressed to suspend projection.

Options						
Disable	5 min	10 min	15 min	20 min	25 min	30 min

Sleep Timer

Choose the length of time before the projector enters standby.

Options							
Disable	30 min	1 hr	2 hr	3 hr	4 hr	8 hr	12 hr

Date and Time Setting

Set the projector clock.

Press **ENTER** and select **Date** or **Time** to view settings for the selected item.

Option	Description
Date	Enter a value for the date in mmyydd format.
Time	Enter a value for the time in hh:mm format.

Schedule Setting

Turn the projector on or off automatically according to the day of the week.

Press **ENTER** and select a day of the week to display options for the selected day.

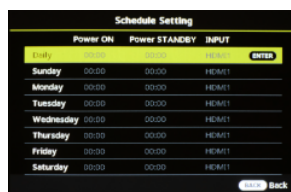

Options							
Daily	Sunday	Monday	Tuesday	Wednesday	Thursday	Friday	Saturday

Choose whether the projector is used on the selected day and if so the input used and the times at which the projector turns on or switches to standby.

Press **ENTER** and select a day of the week to display options for the selected day.

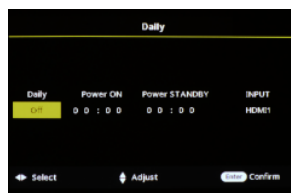

⚠ CAUTIONS

- **Date and Time Setting** will be reset automatically if the projector is without power for three consecutive hours. Leave the projector on standby when using **Schedule Setting**.
- **Schedule Setting** can only be used if the projector clock has been set using **Date and Time Setting**.

📌 TIP

Enabling **Daily** configures the projector to operate on the same schedule every day, regardless of the day of the week.

Control Channel

Choose the type of input used for projector control.

Options	
LAN · RS-232C	HDBaseT

Standby Settings

Adjust network standby settings.

Press **ENTER** to display options and then select the desired item.

Enable Network Standby Mode

Selecting **On** enables network standby when the projector is in standby mode. The indicator lamps will flash red.

Options	
On	Off

Switch to Normal Standby Mode

Choose how long **Enable Network Standby Mode** remains on.

Options				
Off	20 min	1 hr	3 hr	6 hr

LAN Settings

Adjust network settings.

Press **ENTER** to display network options and then adjust them as desired. Highlight **Apply** and press **ENTER** to apply changes when settings are complete.

Wired LAN

Option	Description
Status	View network status (display only).
AMX Device Discovery	If On is selected, the projector will automatically be detected by AMX controllers connected to the current network.
DHCP	Select On when using the Dynamic Host Configuration Protocol (DHCP). The settings below can be adjusted when Off is selected.
Projector IP Address	Enter an IP address.
Subnet Mask	Enter a sub-net mask.
Default Gateway	Enter the default gateway address.
DNS Server	Enter a DNS server address.
Apply	Press ENTER to apply changes to settings.

MAC Address

View the projector's MAC address (display only).

INFORMATION

View current system status.

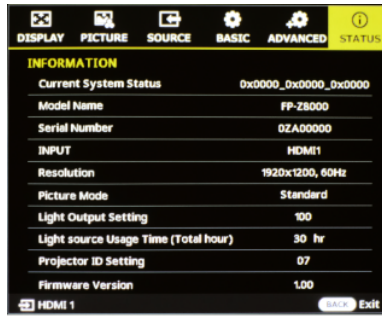

Option	Description
Current System Status	Current system status.
Model Name	The projector model name.
Serial Number	The projector serial number.
INPUT	The current input mode (← INPUT (.././menu/source/#input)).
Resolution	The output resolution.
Picture Mode	The current picture mode (← Picture Mode (.././menu/picture/#picture_mode)).
Light Output Setting	The current output level for the projector light source (← Light Output Setting (.././menu/system_setup_advanced/#light_output_setting)).
Light Source Usage Total Time	The length of time the projector light source has been in use.
Projector ID Setting	The projector ID (← Choosing IDs (.././about_this_product/remote_control/#id_set)).
Firmware Version	The version number of the current projector firmware.

Overview

- ▼ About the Warping and Blending Tool
- ▼ Warping and Blending Tool System Requirements
- ▼ Examples
- ▼ What the Warping and Blending Tool Can Do for You

About the Warping and Blending Tool

Use Warping and Blending Tool software for geometric correction (warping) and to blend the edges of images from multiple projectors.

Adjustments can be made using the keyboard and mouse. Gamma adjustment can be applied to overlaps and edge blending. Up to four projectors can be controlled at a time.

Warping and Blending Tool System Requirements

Supported operating systems	<ul style="list-style-type: none">• Windows 8.1 (32- and 64-bit editions)• Windows 10 (32- and 64-bit editions)
Memory	Memory requirements are those for the operating system.
Display resolution	1024 × 768 pixels or more
Supported languages	English only

Examples

Warping

Correct for warping when pictures are projected onto curved or other irregular surfaces.

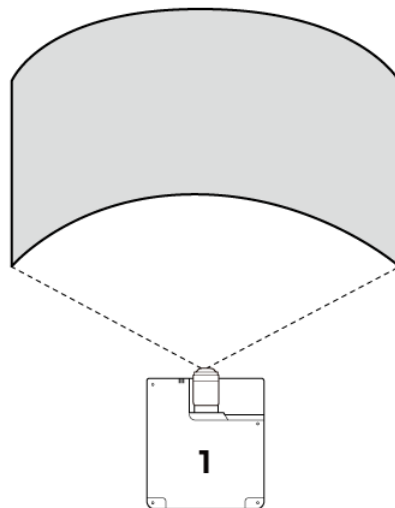

Blending

Create a single large picture by projecting smaller component images from multiple projectors so that they slightly overlap. The seams between the component images are hidden by blending the edges.

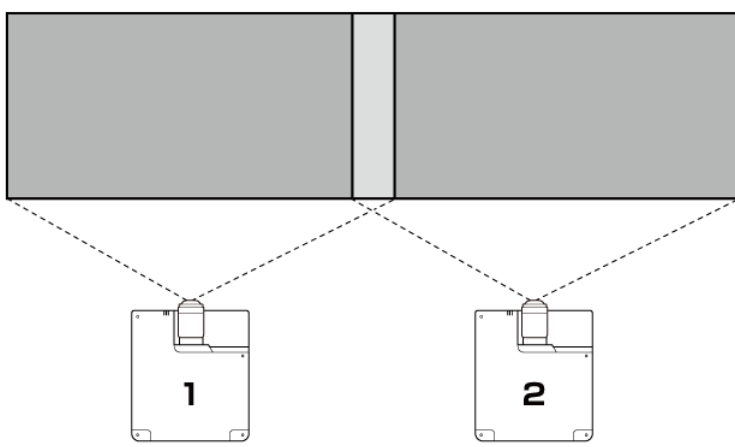

Stacking

Stack pictures from multiple projectors to create a single brighter image.

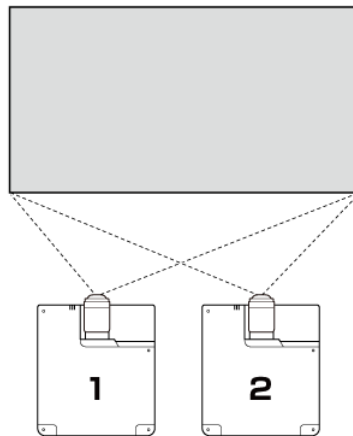

What the Warping and Blending Tool Can Do for You

Using the Warping and Blending Tool, you can:

- project images onto curved and other irregular surfaces,
- project images using multiple projectors,
- stack images, and
- compensate for variations in color and black level.

Workflow

The Warping and Blending Tool workflow is described below.

- ▼ Ready the Projectors
- ▼ Connecting the Source and Preparing Content
- ▼ Ready a Computer and Install the Software

Readying the Projectors

Ready the FP-Z8000 projectors.

Connecting the Source and Preparing Content

Connect a computer or HDMI device to the projectors' HDMI 2 ports. The default input signal resolution for the HDMI 2 connectors is WUXGA (1920 × 1200).

Input signal resolution can be adjusted using the Warping and Blending Tool but is otherwise fixed.

Single Projector (Image Signal Processed Using the Warping and Blending Tool)

- ① Computer USB connector
- ② HDMI connector on source device

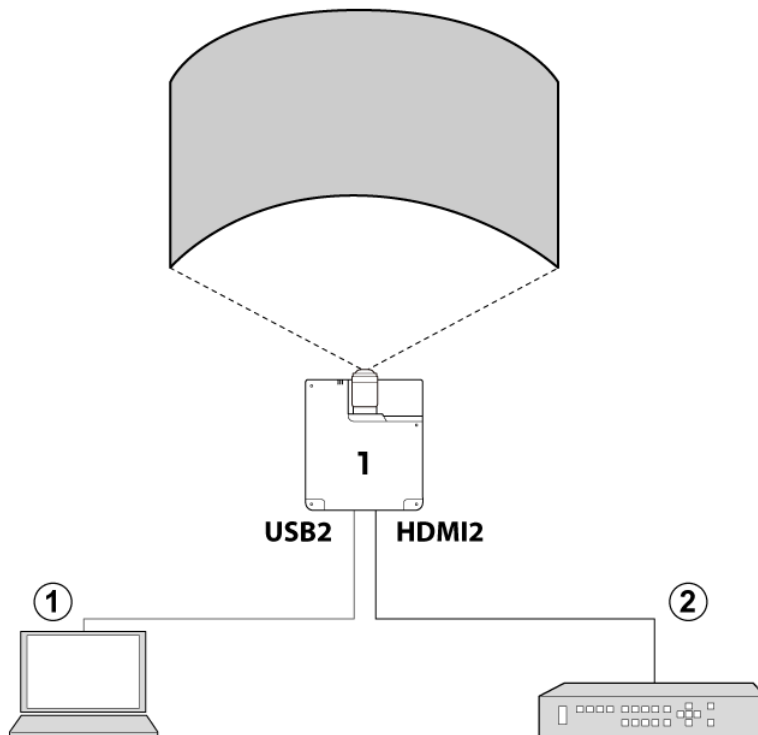

Two Projectors (Image Signal Split Using the Warping and Blending Tool)

- ① Computer USB connector
- ② HDMI connector on source device
- ③ HDMI signal splitter

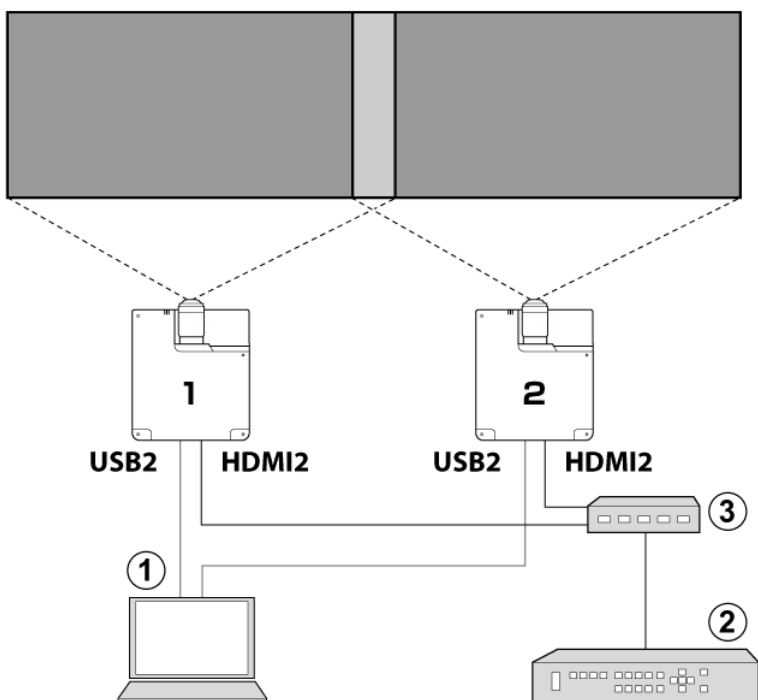

- Image resolution is limited by the maximum screen resolution (1920 × 1200).
- Images input at maximum resolution are cropped and enlarged according to the image to be projected.

Image Signal Spilt Using a Third-Party Media Player or Multi-Display Controller for Maximum Screen Resolution

- ① Computer USB connector
- ② HDMI connector on source device
- ③ Third-party multi-display controller or similar

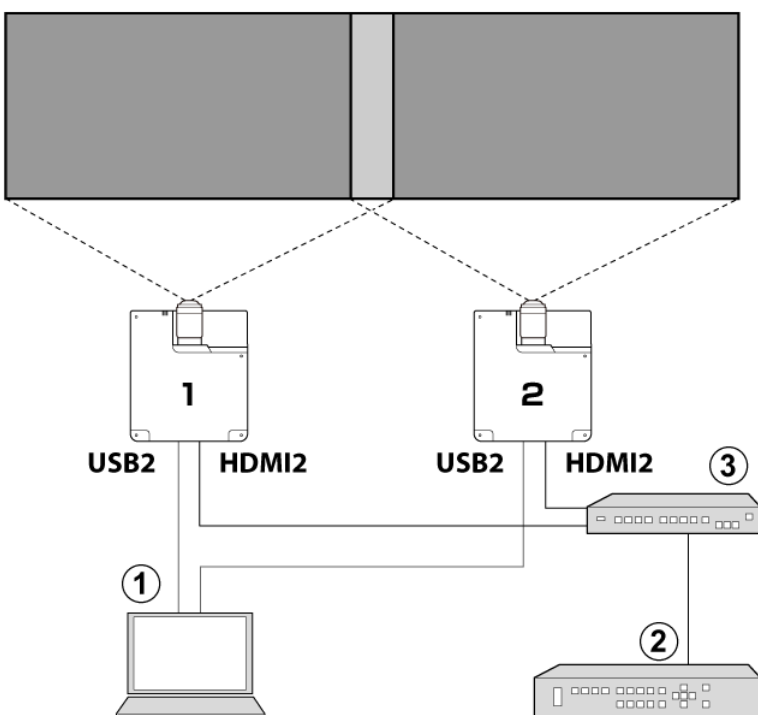

Use a third-party multi-media player or multi-display controller to split the image and synchronize playback. The Warping and Blending Tool will be used solely for blending and warping.

Ready a Computer and Install the Software

Supported operating systems

- Windows 8.1 (32- and 64-bit editions)
- Windows 10 (32- and 64-bit editions)

Warping and Blending Tool Software

Download it here.

https://www.fujifilm.com/products/optical_devices/projector/fpz8000/index.html
(https://www.fujifilm.com/products/optical_devices/projector/fpz8000/index.html)

USB Projector Settings Driver

Download it here.

https://www.fujifilm.com/products/optical_devices/projector/fpz8000/index.html
(https://www.fujifilm.com/products/optical_devices/projector/fpz8000/index.html)

Installation

Extract the zip file you downloaded and double-click "setup.exe" to launch the installer. Follow the on-screen instructions to complete installation.

Download the Warping and Blending Tool and the USB driver **here**
(https://www.fujifilm.com/products/optical_devices/projector/fpz8000/index.html).

- Warping and Blending Tool *.**.exe
 - CDM21224_setup.exe
-

- 1** Exit any applications that may be running.
- 2** Extract the Warping and Blending tool and USB driver zip files and follow the on-screen instructions.
- 3** Exit the installers when installation is complete. Shortcuts will be created on the desktop.

Connections

Connect the **FP-Z8000** (①) to the **source (HDMI output) device** (②) and the computer to which you installed the **Warping and Blending Tool** (③).

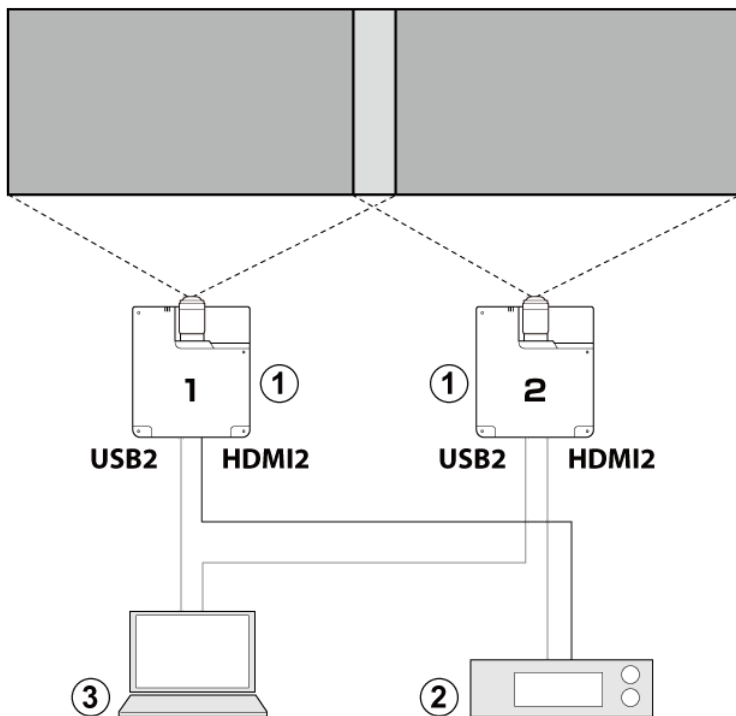

TIPS

- Adjust focus and choose an aspect ratio on the FP-Z8000 prior to connection.
- Restore the default keystone and corner fit settings.
- Do not turn the FP-Z8000 or computer off while adjusting settings with the Warping and Blending Tool. If you do turn either device off, you will need to re-establish the connection between the FP-Z8000 and the Warping and Blending Tool.

Launch and Setup

⚠ CAUTIONS

- Setup should be performed with the FP-Z8000 connected to the computer running the Warping and Blending Tool.
- Set the scale of the computer display to 100%. Other settings could prevent access to some parts of the application.

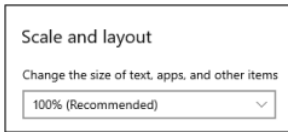

- 1 Launch the Warping and Blending Tool on the computer.

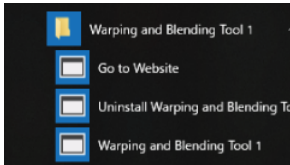

- 2 Select **New Project** in the **File** menu.

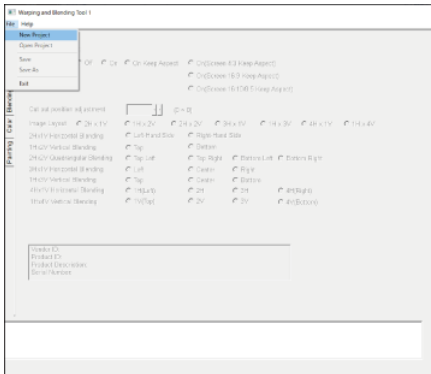

- 3 Go to the **Resolution** tab in the **New Project** window and choose a resolution. Match the FP-Z8000's output resolution to the input signal. Once you have chosen a resolution, the content displayed by the projector will switch from an image to a black screen.

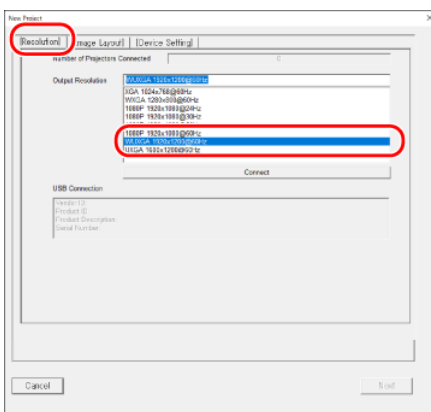

⚠ CAUTION

At default settings, the input signal resolution is fixed at 1920 × 1200. Input at resolutions other than the selected value may produce unexpected results.

- 4 Link to the projectors.

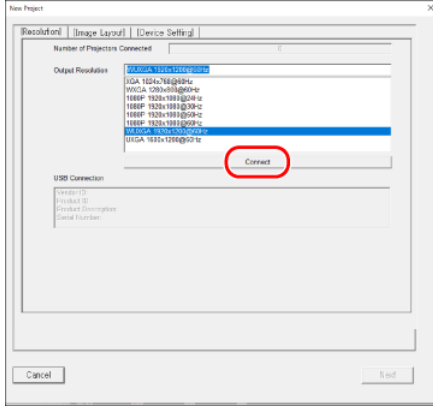

Click **Connect** and link to the projectors.

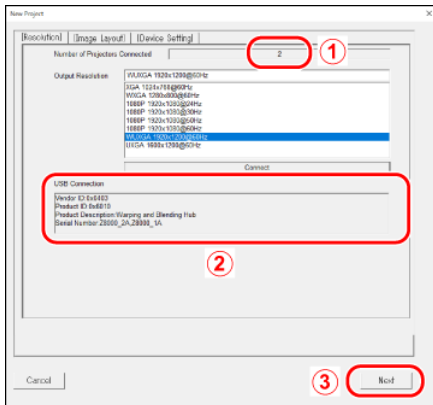
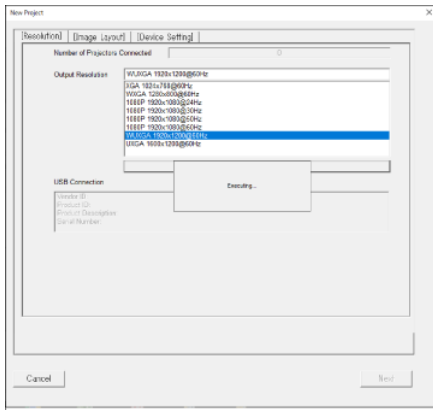

- ① The number of projectors connected.
- ② Device information for the connected projectors.
- ③ Click **Next** to proceed when settings are complete.

TIP

With multiple projectors, it may take some time to establish connections after you click **Connect**.

5 Choose a layout for the projected images.

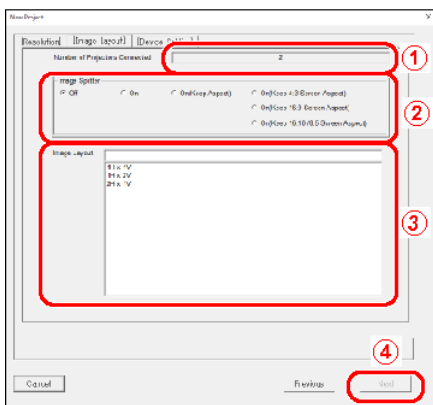

- ① The number of projectors connected.
- ② **Image Splitter** settings.
Enable or disable image splitting using the Warping and Blending Tool.

Off	Select this option if you intend to split the image by some means other than the Warping and Blending Tool.
On	Select On to enable image splitting using the Warping and Blending Tool. Images will not be projected at their original aspect ratios but instead at the aspect ratio selected via edge blending.
On (KeepAspect)	Images are projected at their original aspect ratios. If the input image and screen aspect ratios differ, the left and right or top and bottom edges of the projected image will be cropped to fit the screen (the crop location can be changed using Cut out position adjustment in the Generic tab).
On Keep 4:3 Screen Aspect	Select this option to project images at the selected screen aspect ratio in cases in which it differs from the aspect ratios of the input images.
On Keep 16:9 Screen Aspect	
On Keep 16:10 Screen Aspect	

TIP

If an option other than **Off** is selected for **Image Splitter**, an alert will be displayed notifying you that the image will be split. Click **OK**.



③ **Image Layout** settings.

- Choose a layout for images displayed using two or more FP-Z8000 projectors.
- The dialog lists the layouts available given the number of projectors connected.

Number of projectors	Option ("H" = horizontal divisions, "V" = vertical divisions)	Image projected				
2	2H1V (Horizontal Blending)	<table border="1"> <tr> <td>Left-hand side</td> <td>Right-hand side</td> </tr> </table>	Left-hand side	Right-hand side		
	Left-hand side	Right-hand side				
1H2V (Vertical Blending)	<table border="1"> <tr> <td>Top</td> </tr> <tr> <td>Bottom</td> </tr> </table>	Top	Bottom			
Top						
Bottom						
3	3H1V (Horizontal Blending)	<table border="1"> <tr> <td>Left</td> <td>Center</td> <td>Right</td> </tr> </table>	Left	Center	Right	
	Left	Center	Right			
1H3V (Vertical Blending)	<table border="1"> <tr> <td>Top</td> </tr> <tr> <td>Center</td> </tr> <tr> <td>Bottom</td> </tr> </table>	Top	Center	Bottom		
Top						
Center						
Bottom						
4	4H1V (Horizontal Blending)	<table border="1"> <tr> <td>1H(Left)</td> <td>2H</td> <td>3H</td> <td>4H(Right)</td> </tr> </table>	1H(Left)	2H	3H	4H(Right)
	1H(Left)	2H	3H	4H(Right)		
	1H4V (Vertical Blending)	<table border="1"> <tr> <td>1V(Top)</td> </tr> <tr> <td>2V</td> </tr> <tr> <td>3V</td> </tr> <tr> <td>4V(Bottom)</td> </tr> </table>	1V(Top)	2V	3V	4V(Bottom)
1V(Top)						
2V						
3V						
4V(Bottom)						
2H2V (Quadrangular Blending)	<table border="1"> <tr> <td>Top Left</td> <td>Top Right</td> </tr> <tr> <td>Bottom Left</td> <td>Bottom Right</td> </tr> </table>	Top Left	Top Right	Bottom Left	Bottom Right	
Top Left	Top Right					
Bottom Left	Bottom Right					

TIP

The layout can be adjusted in the **Generic** tab.

- ④ Click **Next** to proceed when settings are complete.

6 Adjust settings in the **Device Setting** tab.

Choose the projector used for each segment when displaying images using two or more FP-Z8000 projectors (**Imabe Layout**).

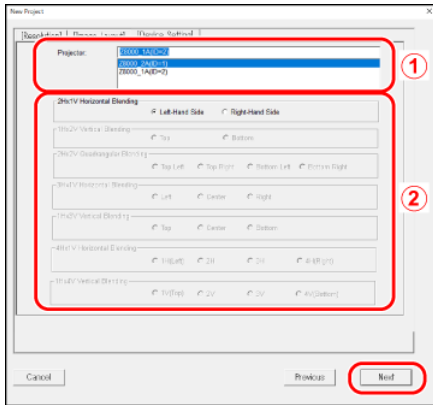

- ① Choose a projector and click **Next**.
- ② Choose the segment displayed by the selected projector and click **Next**.

TIPS

- If you are using only one projector, the only option available will be 1H*1V and the start dialog will be displayed.
- The projector ID shown in the dialog is projected on the screen.

7 When settings are complete, the following dialog will be displayed, opened to the **Generic** tab.

The settings selected in the preceding steps will be displayed and can be adjusted as desired.



- ① Select the projector before adjusting settings. Any changes will apply only to the selected FP-Z8000 projector. Selecting an FP-Z8000 displays the projector's ID (1 through 4) on the screen.
- ② The selected projector's ID.
- ③ Select tabs (**Warping**, **Blending**, **Color**, or **Painting**) and adjust settings.
- ④ **Cut out position adjustment:** Choose where source information is displayed. Choose vertical and horizontal offsets, in pixels. Changes apply to both Device 1 and Device 2. Changes apply to all connected projectors.

*In the following example, the source information is offset vertically by the amount selected for **Cut out position adjustment** but is not offset horizontally (the projected image is also offset, and this also applies when the information is offset horizontally).*

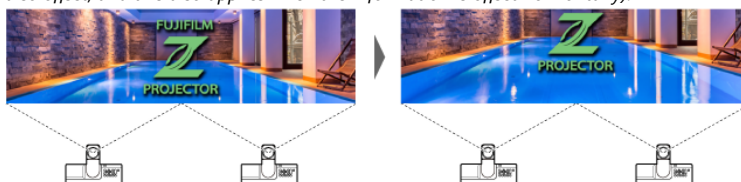

Warping (Geometric Correction)

Correct for warping when images are projected onto curved or other irregular surfaces.

Follow the steps below.

1 In the **Generic** tab, select the projector to which settings will be applied.

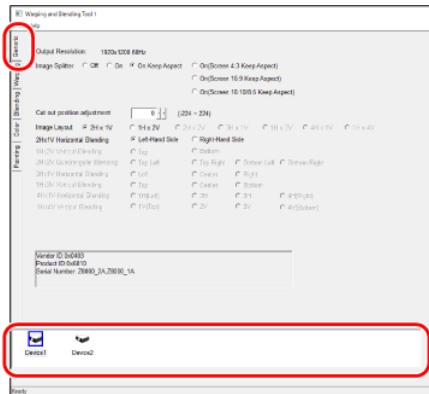

2 **Warping** options will be displayed.

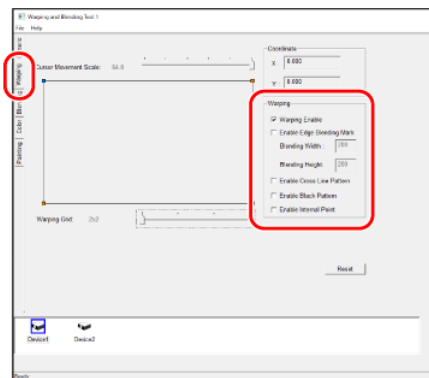

Warping Enable	Enable warping.
Enable Edge blending mark	Display edge blending marks together with the blending width and height. Use this option to choose the edge blending position when warping is enabled. The values for Blending Width and Blending Height are adjusted using edge blending (Blending (Edge Blending) (../blending/index.html)).
Enable Cross Line Pattern	Project a grid pattern as a guide to warping. The input image will not be displayed.
Enable black Pattern	Select this option for a solid black display. The input image will not be displayed.
Enable Internal Point	Select this option to add adjustment points inside the grid squares. Select points with the mouse and use the up, down, left, and right arrows on the computer keyboard to adjust the projected image.

3 Click the desired adjustment (correction) point in the warping display.

Adjustments are made using the up, down, left, and right arrows on the computer keyboard.

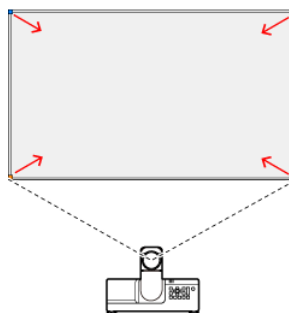
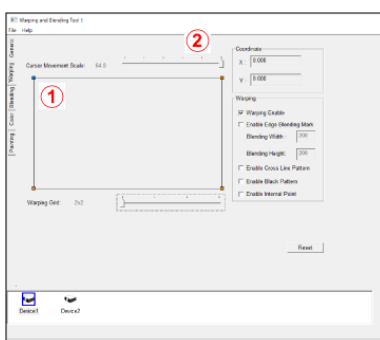

Example

- 1 Select the desired point using the mouse.
- 2 Choose the amount of adjustment applied with each key press.
- 3 Use the up, down, left, and right arrows on the computer keyboard to adjust the projected image.
The changes made by moving the blue point are visible in the projected image. The image in the warping tool display does not change.



Geometric correction applies within the frame. Points cannot be moved outside the boundaries of the frame.

- ▼ Cursor Movement Scale
- ▼ Warping Grid
- ▼ Coordinate
- ▼ Warping
- ▼ Reset

Cursor Movement Scale

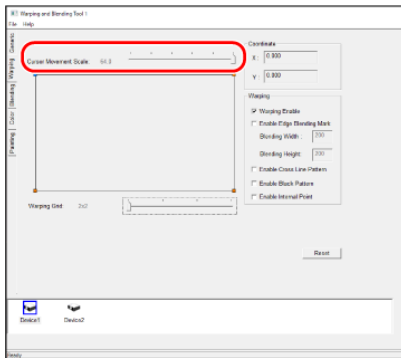

Choose the amount the selected adjustment point (shown in blue) moves with each key press. The amount can be varied by up to six levels.

Amount (pixels)					
0.5	1.0	4.0	16	32	64

Warping Grid

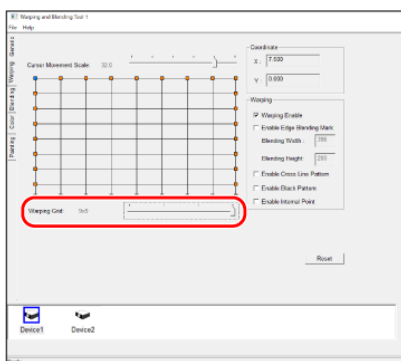

Choose the number of grid squares available for selection.

Options			
2x2	3x3	5x5	9x9

2x2

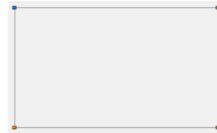

9x9

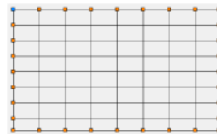

Coordinate

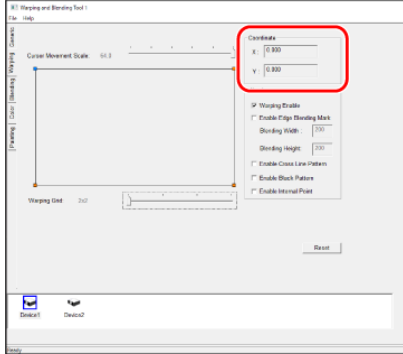

The coordinates of the selected adjustment point (shown in blue).

Warping

Select adjustment points and position them using the up, down, left, and right arrows on the computer keyboard. Repeat for all the desired points.

You will need to select an adjustment point anew after moving the **Cursor movement scale** or **Warping Grid** sliders.

TIP

Start with a warping grid with fewer squares before increasing the square count. Settings applied with lower square counts take priority.

Example: If you make adjustments with a 9×9 grid before making adjustments with a 2×2 grid, the adjustments made with the 2×2 grid will take priority.

CAUTIONS: Saving Warping Settings

- Before saving warping settings, be sure that **Warping Enable** is checked.
- Warping settings can be saved in CSV format using the **Save as** option in the **File** menu. Name the file as desired.
- Settings for each connected projector must be saved separately. You will also need to load a separate saved CSV settings file for each projector.
- More information on saving settings is available in **“Saving Project Info** (`../warping_blending/information_save_call/#save`)”.

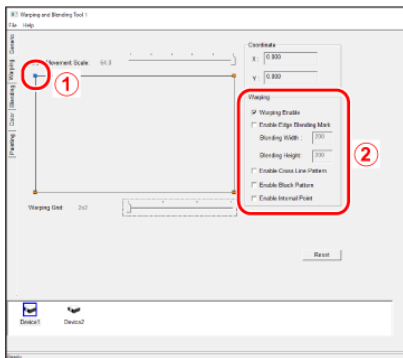

① Move the blue point to correct for warping.

- The changes are visible in the projected image.
- The image in the warping tool display does not change.

② Warping options

Warping Options

- **Warping Enable:** Enable warping.
- **Enable Edge blending mark:** Display edge blending marks together with the blending width and height.
 - **Blending Width:** The amount, in pixels, by which the projected images overlap horizontally.
 - **Blending Height:** The amount, in pixels, by which the projected images overlap vertically.

The values can be adjusted using edge blending (**Blending (Edge Blending)** (`../blending/index.html`)).

- **Enable Cross Line Pattern:** Select this option to display a grid on the projection screen. The input image will not be displayed.

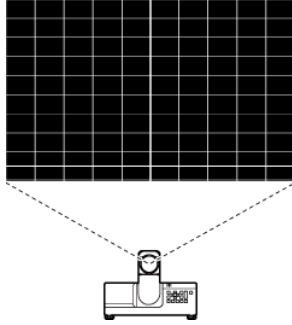

- **Enable black Pattern:** Select this option for a solid black display. The input image will not be displayed.
- **Enable Internal Point:** Select this option to add adjustment points inside the grid squares.
Select points with the mouse and use the up, down, left, and right arrows on the computer keyboard to adjust the projected image.

The change made, for example, by pressing the right arrow on the computer keyboard when a dot is selected will be visible in the projected image.

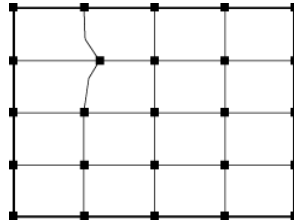

Reset

Reset all adjustments to their default values. For information on saving current settings, see [Saving Project Info \(../warping_blending/information_save_call/#save\)](#).

Blending (Edge Blending)

Smooth the edges between the component images from each projector, seamlessly blending them into a single picture.

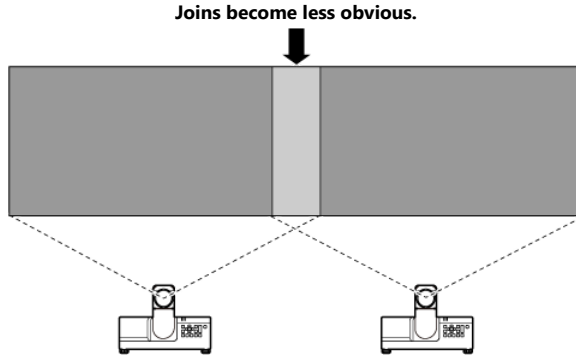

Follow the steps below.

- 1 In the **Generic** tab, select the projector to which settings will be applied.

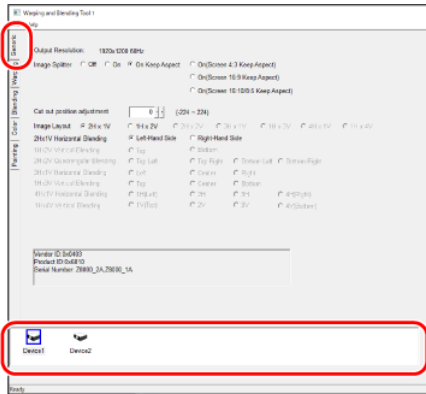

- 2 In the **Blending** tab, place checks in the **Enable** check boxes for the portions of the images to which you wish blending to apply and adjust settings as desired.

The check boxes are enabled automatically when you choose a device.

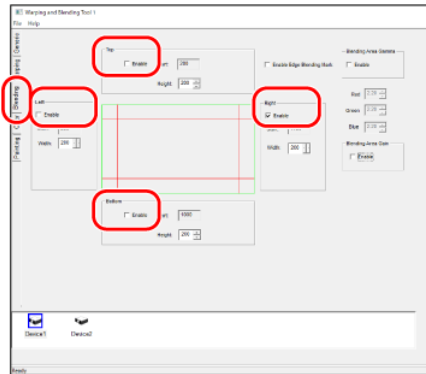

TIP

Use warping for fine adjustments to overlaps.

- 3 In the **Blending** tab, select **Enable** for blending area gamma and gain.

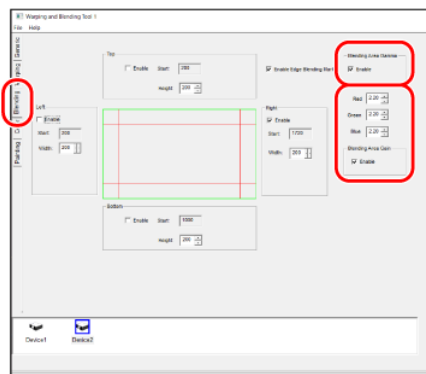

Blending Options

Selecting the **Blending** tab displays (edge) blending options.

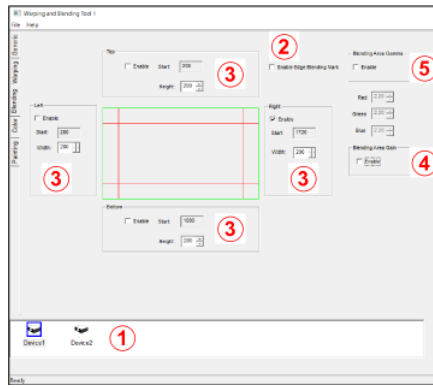

①	Select a projector.
②	<p>Enable Edge Blending Mark: Select this option to display marks showing the overlap between the images from two projectors. When the blending areas are precisely matched, the red and green lines will blend together, turning yellow.</p>
③	<p>Top, Left, Right, and Bottom: Choose the areas to which edge blending applies.</p> <ul style="list-style-type: none"> • Enable: Select this option to enable edge blending. • Start (green lines): The starting point for edge blending. • Width and Height (red lines): The width and height of the joins. (*1) <p>*1 The width and height of each join can be from 16 to 512 pixels. Enter values directly or choose a values using the left and right buttons.</p> <p>The widths of the left and right joins are always the same, as are the heights of the top and bottom joins. Before using blending with three or more projectors, position of the projected images appropriately.</p>
④	Blending Area Gain: Select this option to apply gradations to the joins.
⑤	Blending Area Gamma: Select this option to adjust the color of the joins. Enter values for gamma of from 0.3 to 3.00. Press ENTER after entering values for each of Red, Green, and Blue.

TIP

You normally will need to enable both **Blending Area Gain** (④) and **Blending Area Gamma** (⑤). Red, green, and blue can be fine-tuned as necessary.

Color (Color Correction)

Make local adjustments to correct variations in color across the picture. Color correction is particularly useful in concealing color variations in blended areas at the joins between the component images. Clicking the **Color** tab displays color options and projects a solid white image onto the screen. Local corrections can be made wherever variations in color exist.

- 1 Click the **Color** tab to display color options (①) and choose a projector to which color correction will be applied (②).

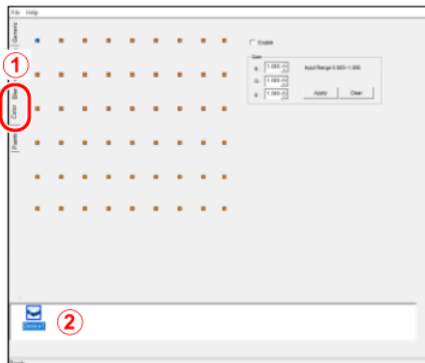

- 2 Choose an area for color correction.

Click the dot representing the area containing the colors you want to correct (the dot will turn blue).

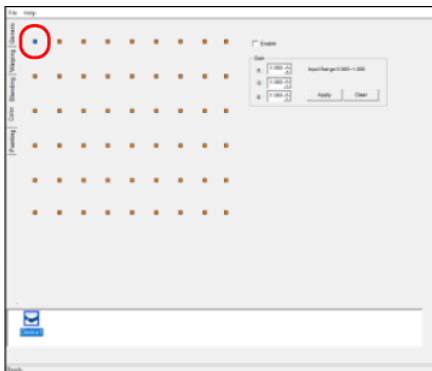

- 3 Adjust color correction settings.

Select **Enable**, adjust gain for any of the red (**R**), green (**G**), and blue (**B**) channels, and click **Apply**. Repeat this process for each of the remaining channels.

To restore gain to default values, click **Clear**.

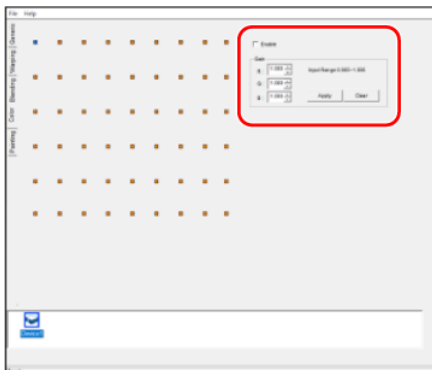

TIP

Be sure to enter a gain value for each of the **R**, **G**, and **B** channels and to click **Apply** each time, as otherwise only the value for the color you edited last will be applied.

- **Wrong:** Enter a value for each of **R**, **G**, and **B** and only then click **Apply**. Only the value for **B** will be updated.
- **Right:** Edit **R** and click **Apply**, edit **G** and click **Apply**, and edit **B** and click **Apply**. The values for all channels will be updated.

Painting

Adjust black levels for all parts of the picture other than the blended areas at the joins between the component images. The black levels for the rest of the picture should match those at the joins. When adjusting black, select **Enable Black** in the **Image Warping** tab to project a solid black image onto the screen.

- **Start:** The shaded areas require adjustment.

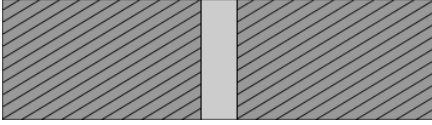

- **Painting:** Black levels are adjusted to match the join.



- **End:** The join is less visible.



TIP

The effects of painting may not be visible depending on projector brightness.

- 1 Click the **Painting** tab to display painting options (1) and choose a projector to which painting will be applied (2).

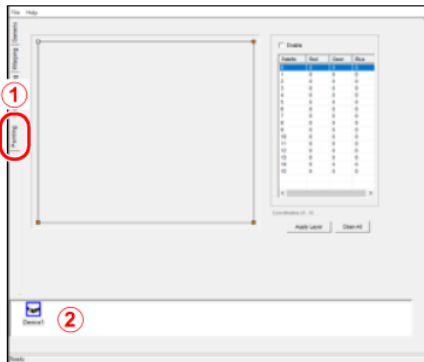

- 2 **Choose an area for painting.**

Keeping your eye on the projected image, select the area you want to edit as defined by its four corners.

Drag the mouse or use the arrow keys on the keyboard to position the selected corner, shown in blue.

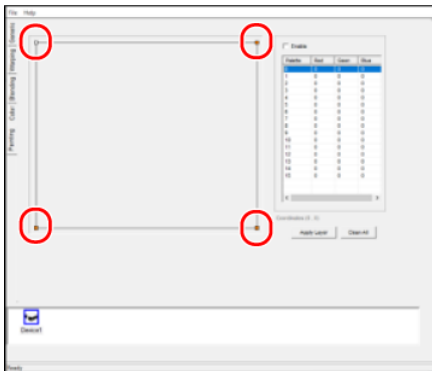

- 3 Select **Enable** and click the first of the selected areas to display a color palette.

Choose a color, click **OK**, and click **Apply Layer** to apply the color to the image displayed by the projector.

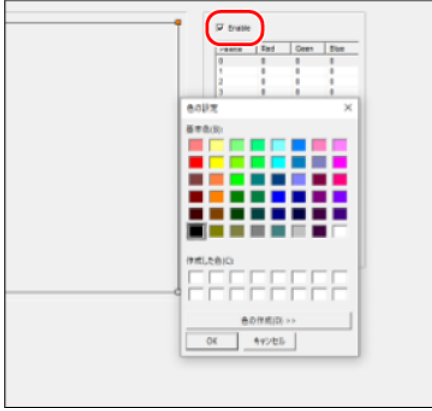

Repeat Steps 2 and 3 to adjust settings as desired for the remaining areas of the image.

Saving and Loading Project Info

▼ Saving Project Info

▼ Loading Project Info

Saving Project Info

Save projector settings. **Generic, Warping, Blending, Color,** and **Painting** settings adjusted or edited using the Warping and Blending Tool are saved to a "*.csv" file on the computer. The changes made using the Warping and Blending Tool will remain in effect on the projectors.

CAUTION

Settings adjusted or edited using the Warping and Blending Tool must be saved separately for each projector (device). Saving settings to your computer allows them to be stored even when the projectors are turned off. Adjustments to settings and the resolution selected for the HDMI 2 input signal are saved and remain in effect until changed in the Warping and Blending Tool.

1 At the bottom of the dialog, choose the projector for which you want to save settings.

2 Select **Save** or **Save as** in the **File** menu.

When naming the files, keep in mind that a separate csv file is required for each projector.

The USB cable for the control connection can be disconnected once settings have been saved.

Loading Project Info

Edit saved projects.

After connecting all the projectors, select **Open Project** in the **File** menu and load the projectors' csv files.

1 After connecting the projectors to the computer and image signal input, launch the Warping and Blending Tool, select **New Project** in the **File** menu, and follow the steps for setting up a new project until you get to the **Generic** tab.

2 Select the projector for which you want to load settings.

3 Select **Open Project** in the **File** menu and choose a file.

Main Specifications

Specifications

		Model name	FP-Z8000	FP-Z6000
DLP chip	Size	0.67 in, 16:10 aspect ratio		
	Display method	1Chip DLP		
	Resolution	2,304,000 pixel (1920 × 1200)		
Lens	Type	Folded two-axial rotatable lens		
	Shift	Electrical: Vertical ±70%, Horizontal ±35%		
	Zoom	Electrical: ×1.0 – ×1.1		
	Throw ratio (TR) ^{*1}	0.34 (Wide) – 0.37 (Telephoto)		
	Focal length	f=5.0 mm (Wide) – 5.5 mm (Telephoto)		
	F No.	F2.3 (Wide) – F2.39 (Telephoto)		
Keystone correction range		Vertical ±5°/Horizontal ±5°		
Light source		Laser diode		
Brightness (ANSI lm ^{*2})		8,000lm	6,000lm	
Light source life ^{*3}		Up to about 20,000 hours		
Contrast ratio ^{*4}		12,000:1		
Projected image size		70–300 inches		
Speaker		10W × 1		
Maximum display resolution (W × H)		WUXGA 1920 × 1200		
Terminals	Video IN terminals	HDMI 1 IN	TypeA HDMI 2.0 (Compatible with HDCP 2.2, Accept 3840 × 2160 60P Input)	
		DisplayPort IN	DisplayPort 20pin Display Port1.2 (Compatible HDCP 1.3, Accept 3840 × 2160 60P Input)	
		SDI IN	BNC 3G/HD/SD SDI Input	
		HDBaseT IN	RJ-45 for video/audio/connection control (Accept 3840 × 2160 60P Input)	
	Control IN/OUT terminals	LAN	RJ-45 for network connection (10BASE-T/100Base-TX)	
		HDBaseT	RJ-45 for projector connection control	
		RS-232C	D-Sub 9Pin for projector connection control	
	Audio IN/OUT terminals	AUDIO IN	3.5mm stereo mini jack	
		AUDIO OUT	3.5mm stereo mini jack	
	Others	USB 1	TypeA for maintenance, DC 5V 1.5A (Max)	
	Warping/Edge blending function	HDMI 2 IN	TypeA HDMI 1.4 (Compatible with HDCP 1.4, Audio input not supported)	—
USB 2		TypeA for warping/edge blending function	—	
Power supply		AC 100–120V, AC 220–240 V 50/60 Hz		
Power consumption		1020W Normal:960W, Eco:620W	642W Normal:604W, Eco:386W	
Power consumption (during standby)		Approx.0.5W, Network standby Approx.3.0W		

Dimensions		460mm (W) × 510mm (D) × 162.5mm (H) (excluding adjustable feet)	
Weight		Approx.18.4 kg (40.6 lb)	Approx.17.5 kg (38.6 lb)
Noise level *5		Normal: 43 dB; Eco: 40 dB	Normal: 41 dB; Eco: 38 dB
Operation environment	Operating temperature	0–40 °C (32–104 °F)	
	Operating humidity	10–90% (without condensation)	
	Storage temperature	–20 – +60 °C (–4 – 140 °F)	
Accessories included		Power cord 3.0m (9.8 ft)	
		Power cord lock	
		Lens cap	
		Remote control	
		Remote control battery (AAA type x2)	
		Basic Manual	

*1 The “throw ratio” is the throw distance divided by the screen width.

*2 The average value for this model at shipment, according to ANSI standards.

*3 The estimated time taken for brightness to drop by half. Varies with the operating environment and conditions of use.

*4 Assumes that dynamic contrast ratio is on.

*5 The average value for this model at shipment.

Supported Resolutions

Image quality may be reduced if the resolution of the input signal exceeds the resolution of the projector's panel.

- ▼ HDMI1 / DisplayPort / HDBaseT PC compatible signal
- ▼ HDMI1 / DisplayPort / HDBaseT Video compatible signal
- ▼ SDI compatible signal
- ▼ HDMI2 Warping / Edge blending function compatible signal (FP-Z8000 only)

HDMI1 / DisplayPort / HDBaseT PC compatible signal

Resolution (Dots)	Signal format	Scanning freq.		Clock freq. (MHz)
		Horizontal(kHz)	Vertical(Hz)	
640 x 480	VGA/60	31.5	59.9	25.2
	VGA/72	37.9	72.8	31.5
	VGA/75	37.5	75.0	31.5
	VGA/85	43.3	85.0	36.0
720 x 400	720x400/70	31.5	70.1	28.3
800 x 600	SVGA/60	37.9	60.3	40.0
	SVGA/72	48.1	72.2	50.0
	SVGA/75	46.9	75.0	49.5
	SVGA/85	53.7	85.1	56.3
	SVGA/120	77.4	119.9	83.0
1024 x 768	XGA/60	48.4	60.0	65.0
	XGA/70	56.5	70.1	75.0
	XGA/75	60.0	75.0	78.8
	XGA/85	68.7	85.0	94.5
	XGA/120	97.6	120.0	115.5
1152 x 864	1152 x 864/75	67.5	75.0	108.0
1280x720	1280 x 720/60	45.0	60.0	74.3
	1280x720/120	90.0	120.0	148.5
1280 x 768	1280 x 768/60	47.4	60.0	68.3
	1280 x 768/60	47.8	59.9	79.5
1280 x 800	WXGA/60	49.7	59.8	83.5
	WXGA/75	62.8	74.9	106.5
	WXGA/85	71.6	84.9	122.5
	WXGA/120	101.6	119.9	146.3
1280 x 1024	SXGA/60	64.0	60.0	108.0
	SXGA/75	80.0	75.0	135.0
	SXGA/85	91.1	85.0	157.5
1280 x 960	1280 x 960/60	60.0	60.0	108.0
	1280 x 960/85	85.9	85.0	148.5
1366 x 768	1366 x 768/60	47.7	59.8	85.5
1440 x 900	WXGA+/60	55.5	60.0	88.8
	WXGA+/60	55.9	59.9	106.5
1400x1050	SXGA+/60	65.3	60.0	121.8

Resolution (Dots)	Signal format	Scanning freq.		Clock freq. (MHz)
		Horizontal(kHz)	Vertical(Hz)	
1600x1200	UXGA	75.0	60.0	162.0
1680x1050	1680x1050/60	64.7	59.9	119.0
	1680x1050/60	65.3	60.0	146.3
640x480@67Hz	MAC13	35.0	66.7	30.2
832x624@75Hz	MAC16	49.7	74.5	57.3
1024x768@75Hz	MAC19	60.2	75.0	80.0
1152x870@75Hz	MAC21	68.7	75.1	100.0
1920x1080@60HZ	1920x1080/60	67.5	60.0	148.5
1920x1200@60HZ	1920x1200/60	74.0	60.0	154.0
1920x1080(VESA)	1920x1080/60	67.2	60.0	173.0
1920x1080@120Hz	1920x1080/120	137.3	120.0	285.5
3840x2160	3840x2160/30	67.5	30.0	297.0
	3840x2160/60 *	135.0	60.0	594.0

* HDBaseT is not supported signal.

HDMI1 / DisplayPort / HDBaseT Video compatible signal

Resolution (Dots)	Signal format	Scanning freq.		Clock freq. (MHz)
		Horizontal(kHz)	Vertical(Hz)	
720 x 480	480p	31.5	59.9	27.0
720 x 576	576p	31.3	50.0	27.0
1280 x 720	720/50p	37.5	50.0	74.3
	720/60p	45.0	60.0	74.3
1920 x 1080	1080/24P	27.0	24.0	74.3
	1080/25P	28.1	25.0	74.3
	1080/30P	33.8	30.0	74.3
	1080/50i	28.1	50.0	74.3
	1080/60i	33.8	60.0	74.3
	1080/50P	56.3	50.0	148.5
3840 x 2160	1080/60P	67.5	60	148.5
	2160/24P	54.0	24	297.0
	2160/25P	56.3	25	297.0
	2160/30P	67.5	30	297.0
	2160/50P *	112.5	50	594.0
	2160/60P *	135.0	60	594.0

* HDBaseT is not supported signal.

SDI compatible signal

Signal format	SDI mode	Signal standards	Color format	Sampling	Bit Depth
NTSC	SD-SDI	SMPTE 259M-C 270Mbps SD	YCbCr	4:2:2	10

Signal format	SDI mode	Signal standards	Color format	Sampling	Bit Depth
PAL	SD-SDI	SMPTE 259M-C 270Mbps SD	YCbCr	4:2:2	10
1080/59i	HD-SDI	SMPTE 292M 1.5Gbps HD	YCbCr	4:2:2	10
1080/60i	HD-SDI	SMPTE 292M 1.5Gbps HD	YCbCr	4:2:2	10
1080/30P	HD-SDI	SMPTE 292M 1.5Gbps HD	YCbCr	4:2:2	10
1080/25P	HD-SDI	SMPTE 292M 1.5Gbps HD	YCbCr	4:2:2	10
1080/50i	HD-SDI	SMPTE 292M 1.5Gbps HD	YCbCr	4:2:2	10
1080/24P	HD-SDI	SMPTE 292M 1.5Gbps HD	YCbCr	4:2:2	10
720/60P	HD-SDI	SMPTE 292M 1.5Gbps HD	YCbCr	4:2:2	10
720/50P	HD-SDI	SMPTE 292M 1.5Gbps HD	YCbCr	4:2:2	10
1080/25sF	HD-SDI	SMPTE 292M 1.5Gbps HD	YCbCr	4:2:2	10
1080/30sF	HD-SDI	SMPTE 292M 1.5Gbps HD	YCbCr	4:2:2	10
1080/50P	3G-SDI	SMPTE 424M 3Gbps Level-A	YCbCr	4:2:2	10
1080/59P	3G-SDI	SMPTE 424M 3Gbps Level-A	YCbCr	4:2:2	10
1080/60P	3G-SDI	SMPTE 424M 3Gbps Level-A	YCbCr	4:2:2	10

HDMI2 Warping / Edge blending function compatible signal (FP-Z8000 only)

Resolution (Dots)	Signal format	Scanning freq.		Clock freq. (MHz)
		Horizontal(kHz)	Vertical(Hz)	
1024 x 768	XGA/60	48.4	60.0	65.0
1280 x 800	WXGA/60	49.7	59.8	83.5
1920 x 1080	1080p/24	27.0	24.0	74.3
1920 x 1080	1080p/30	33.8	30.0	74.3
1920 x 1080	1080p/50	56.3	50.0	148.5
1920 x 1080	1080p/60	67.5	60.0	148.5
1920 x 1200	WUXGA/60	74.0	60.0	154.0

Projection Distance

- ▼ Lens Shift Range
- ▼ Projection Distance

Lens Shift Range

Lens Shift Range: Landscape Orientation

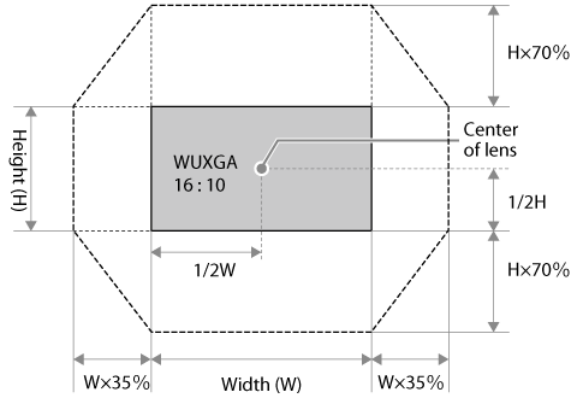

Projection Distance

Landscape Orientation

More details on projection distance are available via a simulator on the Fujifilm website:
<https://optics.fujifilm.com/projector/simulator/en.html>
<https://optics.fujifilm.com/projector/simulator/en.html>

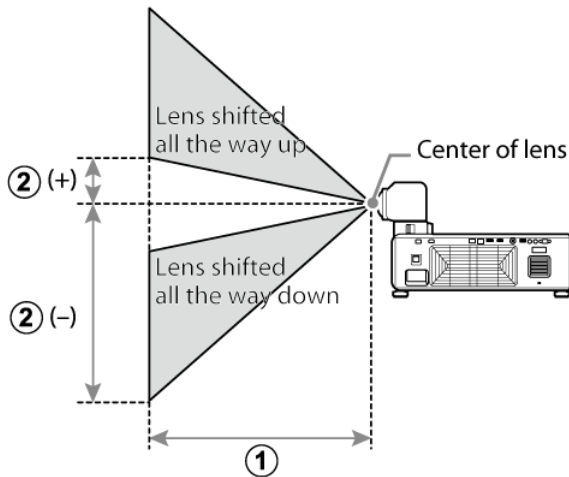

- ① Projection distance (cm/in.), minimum (projector zoomed all the way out) to maximum (projector zoomed all the way in)
 ② Vertical distance from center of lens to bottom of screen (cm/in)

Projection Distance Tables

Screen dimensions (16:10)		① Projection distance (cm/in.) min.–max. zoom	② Vertical shift (cm/in.) lowest to highest
Diagonal (in.)	W × H (cm/in.)		
70	151 × 94 / 59.4 × 37.0	50– 55 / 19.7–21.7	–113 to +19 / –44.5 to +7.5
80	172 × 108 / 67.7 × 42.5	58– 64 / 22.8–25.2	–129 to +22 / –50.8 to +8.7
90	194 × 121 / 76.4 × 47.6	65– 72 / 25.6–28.3	–145 to +24 / –57.1 to +9.4

Screen dimensions (16:10)		① Projection distance (cm/in.) min.–max. zoom	② Vertical shift (cm/in.) lowest to highest
Diagonal (in.)	W × H (cm/in.)		
100	215 × 135 / 84.6 × 53.1	72– 80 / 28.3–31.5	–162 to +27 / –63.8 to +10.6
120	258 × 162 / 101.6 × 63.8	87– 96 / 34.3–37.8	–194 to +32 / –76.4 to +12.6
150	323 × 202 / 127.2 × 79.5	109–121 / 42.9–47.6	–242 to +40 / –95.3 to +15.7
200	431 × 269 / 169.7 × 105.9	147–161 / 57.9–63.4	–323 to +54 / –127.2 to +21.3
250	538 × 337 / 211.8 × 132.7	184–202 / 72.4–79.5	–404 to +67 / –159.1 to +26.4
300	646 × 404 / 254.3 × 159.1	221–243 / 87.0–95.7	–485 to +81 / –190.9 to +31.9

Screen dimensions (16:9)		① Projection distance (cm/in.) min.–max. zoom	② Vertical shift (cm/in.) lowest to highest
Diagonal (in.)	W × H (cm/in.)		
70	155 × 87 / 61.0 × 34.3	52– 57 / 20.5–22.4	–111 to +24 / –43.7 to +9.4
80	177 × 100 / 69.7 × 39.4	59– 65 / 23.2–25.6	–127 to +28 / –50.0 to +11.0
90	199 × 112 / 78.3 × 44.1	67– 74 / 26.4–29.1	–143 to +31 / –56.3 to +12.2
100	221 × 125 / 87.0 × 49.2	75– 82 / 29.5–32.3	–159 to +35 / –62.6 to +13.8
120	266 × 149 / 104.7 × 58.7	90– 99 / 35.4–39.0	–191 to +42 / –75.2 to +16.5
150	332 × 187 / 130.7 × 73.6	113–124 / 44.5–48.8	–239 to +52 / –94.1 to +20.5
200	443 × 249 / 174.4 × 98.0	151–166 / 59.4–65.4	–318 to +69 / –125.2 to +27.2
250	553 × 311 / 217.7 × 122.4	189–208 / 74.4–81.9	–398 to +86 / –156.7 to +33.9
300	664 × 374 / 261.4 × 147.2	227–250 / 89.4–98.4	–477 to +104 / –187.8 to +40.9

Screen dimensions (4:3)		① Projection distance (cm/in.) min.–max. zoom	② Vertical shift (cm/in.) lowest to highest
Diagonal (in.)	W × H (cm/in.)		
60	122 × 91 / 48.0 × 35.8	49– 54 / 19.3–21.3	–110 to +18 / –43.3 to +7.1
70	142 × 107 / 55.9 × 42.1	57– 63 / 22.4–24.8	–128 to +21 / –50.4 to +8.3
80	163 × 122 / 64.2 × 48.0	65– 72 / 25.6–28.3	–146 to +24 / –57.5 to +9.4
90	183 × 137 / 72.0 × 53.9	74– 81 / 29.1–31.9	–165 to +27 / –65.0 to +10.6
100	203 × 152 / 79.9 × 59.8	82– 91 / 32.3–35.8	–183 to +30 / –72.0 to +11.8
120	244 × 183 / 96.1 × 72.0	99–109 / 39.0–42.9	–219 to +37 / –86.2 to +14.6
150	305 × 229 / 120.1 × 90.2	124–137 / 48.8–53.9	–274 to +46 / –107.9 to +18.1
200	406 × 305 / 159.8 × 120.1	166–183 / 65.4–72.0	–366 to +61 / –144.1 to +24.0
240	488 × 366 / 192.1 × 144.1	200–220 / 78.7–86.6	–439 to +73 / –172.8 to +28.7



 **TIP**

Figures are approximate, differing from the actual values by a few percent.

Geometric Correction Range

TIP

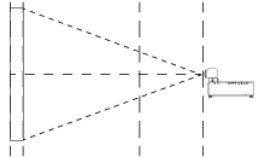
Figures are approximations and may vary from the actual values by a few percent.

Lens shift position	Keystone correction *1	
	(1) Horizontal	(2) Vertical
	Correction angle "A"	Correction angle "B"
±0% vertical (V), ±0% horizontal (H) 	±5°	±5°
+50% vertical (V), ±0% horizontal (H) 	—	—

*1 Amount applied using Keystone in the projector menus.

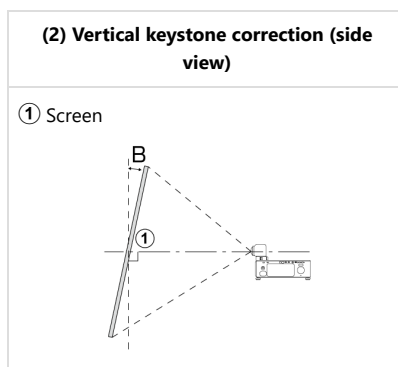
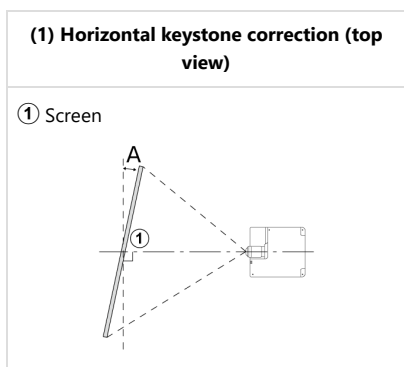

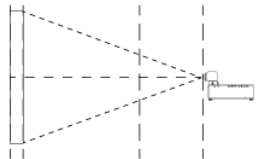
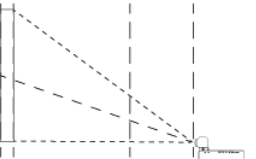
Lens shift position	Screen curvature correction *2 (minimum R/L value)			
	Concave		Convex	
	(3) Horizontal	(4) Vertical	(5) Horizontal	(6) Vertical
±0% vertical (V), ±0% horizontal (H) 	1.10	0.83	4.83	2.09
±50% vertical (V), ±0% horizontal (H) 	2.69	1.66	4.83	3.66

*2 Amount applied using the "Warping and Blending Tool" computer software's warping feature (FP-Z8000 only). Adjustments to focus may fail to produce the desired results at higher values.

(3) Concave horizontal curvature correction (top view)

(4) Concave vertical curvature correction (side view)

(3) Concave horizontal curvature correction (top view)

- ① Screen
- ② Arc center
- L: Throw distance
- R: Arc radius

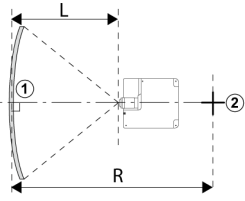

(4) Concave vertical curvature correction (side view)

- ① Screen
- ② Arc center
- L: Throw distance
- R: Arc radius

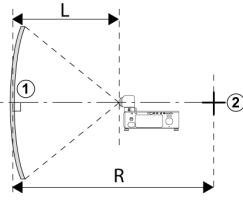

(5) Convex horizontal curvature correction (top view)

- ① Screen
- ② Arc center
- L: Throw distance
- R: Arc radius

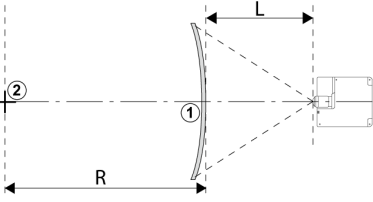

(6) Convex vertical curvature correction (side view)

- ① Screen
- ② Arc center
- L: Throw distance
- R: Arc radius

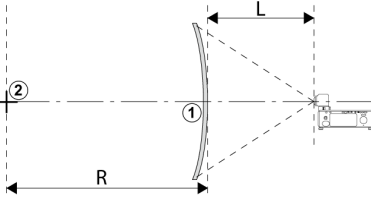

PJLink Commands

The network feature supports Class 1 and 2 PJLink commands.

Projector settings can be adjusted and projector status queried from the computer using PJLink protocol.

▼ PJLink Class 1 Commands

▼ PJLink Class 2 Commands

PJLink Class 1 Commands

The projector supports the following PJLink commands. User-supplied information is represented by asterisks ("*").

Command	Control details	Parameter/response string	Remark
%1POWR	Power supply control	1	Power on
		0	Standby
%1POWR ?	Power supply status query	1	Power on
		0	Standby
%1INPT	Input selection	31	HDMI1
		32	HDMI2
		33	DisplayPort
		34	HDBaseT
		35	SDI
%1INPT ?	Input selection query	31	HDMI1
		32	HDMI2
		33	DisplayPort
		34	HDBaseT
		35	SDI
%1AVMT	AV mute	11	Video mute ON
		10	Video mute OFF
		21	Audio mute ON
		20	Audio mute OFF
		31	Video and audio mute ON
		30	Video and audio mute OFF
%1AVMT ?	AV mute status query	11	Video mute ON
		21	Audio mute ON
		31	Video and audio mute ON
		30	Video and audio mute OFF
%1ERST ?	Error status query	10	No fan error
		11	Fan error warning
		12	Fan error
		30	No temperature error
		31	Temperature error warning
		32	Temperature error
%1LAMP ?	Light source status query	***	Light source runtime: ***hours
%1INST ?	Input selection list query	31 / HDMI1	HDMI1

Command	Control details	Parameter/response string	Remark
		32 / HDMI2	HDMI2
		33 / DisplayPort	DisplayPort
		34 / HDBaseT	HDBaseT
		35 / SDI	SDI
%1NAME ?	Projector name query	FP-Z8000	Projector name
%1INF1 ?	Manufacturer name query	FUJIFILM	Manufacturer name
%1INF2 ?	Model name query	FP-Z8000	Model name
%1INF0 ?	Other information query	WUXGA Projector	Other information
%1CLSS ?	Class information query	CLASS2	Class for PJLink

PJLink Class 2 Commands

Command	Control details	Parameter/response string	Remark	
%2SRCH	Projector search	****.***.***.***	MAC address	
%2LKUP=	Link up notification	****.***.***.***	MAC address	
%2ERST=	Error notification	1st	0	No fan error
			1	Fan error warning
			2	Fan error
		2nd	0	-
			1	No temperature error
		3rd	2	Temperature error warning
			0	Temperature error
		4th	0	-
		5th	0	-
6th	0	-		
%2POWR=	Power supply status notification	0	Standby	
		1	Power on	
%21INPT=	Input selection notification	31	HDMI1	
		32	HDMI2	
		33	DisplayPort	
		34	HDBaseT	
		35	SDI	
%2INPT	Input selection	31	HDMI1	
		32	HDMI2	
		33	DisplayPort	
		34	HDBaseT	
		35	SDI	
%2INPT ?	Input selection query	31	HDMI1	
		32	HDMI2	
		33	DisplayPort	
		34	HDBaseT	
		35	SDI	

Command	Control details	Parameter/response string		Remark
%21INST ?	Input selection list query	1st	31 / HDMI1	HDMI1
		2nd	32 / HDMI2	HDMI2
		3rd	33 / DisplayPort	DisplayPort
		4th	34 / HDBaseT	HDBaseT
		5th	35 / SDI	SDI
%2SVER ?	Software version query	*.*/*.**		Projector software ver / LAN software ver
%2INNM ?	Input terminal name query	1st	HDMI1	HDMI1
		2nd	HDMI2	HDMI2
		3rd	DisplayPort	DisplayPort
		4th	HDBaseT	HDBaseT
		5th	SDI	SDI
%2IRES ?	Input signal resolution query	1st	****	Horizontal resolution
		2nd	****	Vertical resolution
%2RRES ?	Recommended resolution query	1st	1920	Horizontal resolution
		2nd	1200	Vertical resolution
%2SVOL	Speaker volume control	0		One level down
		1		One level up
%2FREZ	Freeze control	1		Freeze
		0		Freeze clear
%2FREZ ?	Freeze status query	1		Freeze
		0		Freeze clear

Projector control

It's possible to control the projector by sending commands through the control channel or LAN.

TIP

Use FUJIFILM PROJECTOR CONTROLLER for projector control via the control channel or LAN. FUJIFILM PROJECTOR CONTROLLER is available for download from the sites below.

<https://global.fujifilm.com/en/business-optical-devices/projector/fpz8000>
(<https://global.fujifilm.com/en/business-optical-devices/projector/fpz8000>)

- When this software is used with FP-Z8000, the firmware version of FP-Z8000 should be 1.06 or later.
- FP-Z5000 is not supported.
- FP-Z6000 is compatible with Fujifilm projector controllers in all firmware versions.

▼ System condition

▼ Control command

▼ Software specification

System condition

Control channel

Item	RS-232C	HDBaseT	LAN
Connection cable	Dsub9	RJ45 (Category 5e or above)	RJ45
Communication mode	RS-232C Asynchronous , Half-duplex communication		TCP: Port23
Baud Rate	115200	9600	
Data Length	8 bit		
Parity Check	None		
Stop Bit	1 bit		
Flow Control	None		

Control command

Power

Read/Write	Operation	Command (ASCII)	Remark
Write	Power On	POWER=ON<CR>	It is effective in the standby state.
Write	Power Off	POWER=OFF<CR>	
Read	Power Status	GET=POWER<CR>	In the case of RS-232C control, It is effective in any power state. In the case of LAN control, It is effective only when the projector is turned on. [Warming Up] POWER=OFF2ON [Cooling Down] POWER=ON2OFF

Source Selection

Read/Write	Operation	Command (ASCII)	Remark
Write	HDMI1	INPUT=HDMI1<CR>	
Write	HDMI2	INPUT=HDMI2<CR>	
Write	Display Port	INPUT=DISPLAYPORT<CR>	
Write	HDBaseT	INPUT=HDBASET<CR>	
Write	SDI	INPUT=SDI<CR>	
Read	Current source	GET=INPUT<CR>	

Audio Control

Read/Write	Operation	Command (ASCII)	Remark
Write	Mute On	MUTE=ON<CR>	
Write	Mute Off	MUTE=OFF<CR>	
Read	Mute Status	GET=MUTE<CR>	
Write	Volume +	RC=VOL_P<CR>	
Write	Volume -	RC=VOL_M<CR>	
Read	Volume Status	GET=AVOL<CR>	

Picture Mode

Read/Write	Operation	Command (ASCII)	Remark
Write	Bright	PICTURE=BRIGHT<CR>	It is effective when there is a video input.
Write	Standard	PICTURE=STANDARD<CR>	
Write	sRGB	PICTURE=SRGB<CR>	
Write	DICOM	PICTURE=DICOM<CR>	
Read	Picture Mode	GET=PICTURE<CR>	
Write	Aspect 4:3	ASPECT=4:3<CR>	
Write	Aspect 16:9	ASPECT=16:9<CR>	
Write	Aspect Auto	ASPECT=AUTO<CR>	
Write	Aspect Real	ASPECT=REAL<CR>	
Write	Aspect 16:10	ASPECT=16:10<CR>	
Read	Aspect Status	GET=ASPECT<CR>	

Operation Settings

Read/Write	Operation	Command (ASCII)	Remark
Write	Front Table	PROJECTION=NONE<CR>	
Write	Rear Table	PROJECTION=REAR<CR>	
Write	Front Ceiling	PROJECTION=CEILING<CR>	
Write	Rear Ceiling	PROJECTION=REAR_CEIL<CR>	
Read	PROJECTION Status	GET=PROJECTION<CR>	
Write	Quick Auto search	QAS=ON<CR>	
Write	Quick Auto search	QAS=OFF<CR>	
Read	Quick Auto search status	GET=QAS<CR>	

Control

Read/Write	Operation	Command (ASCII)	Remark
------------	-----------	-----------------	--------

Read/Write	Operation	Command (ASCII)	Remark
Read	LIGHT Hour	GET=PJUSGT<CR>	
Write	LIGHT Mode Normal	LIGHT=NORMAL<CR>	
Write	LIGHT Mode Economic	LIGHT=ECO<CR>	
Read	LIGHT Mode Status	GET=LIGHT<CR>	
Write	Freeze On	FREEZE=ON<CR>	It is effective when there is a video input.
Write	Freeze Off	FREEZE=OFF<CR>	
Read	Freeze Status	GET=FREEZE<CR>	
Write	Menu On	MENU=ON<CR>	
Write	Menu Off	MENU=OFF<CR>	
Write/Write	BACK	RC=BACK<CR>	
Write	Up	RC=UP<CR>	
Write	Down	RC=DOWN<CR>	
Write	Right	RC=RIGHT<CR>	
Write	Left	RC=LEFT<CR>	
Write	ENTER	RC=ENTER<CR>	
Write	Stop lens operation	RC=STOP<CR>	When FOCUS1 / 2, zoom, and lens shift move, this command can stop the lens operation. It can be used with the firmware version 1.06 or later.
Write	High Altitude mode On	HIGHALT=ON<CR>	
Write	High Altitude mode Off	HIGHALT=OFF<CR>	
Read	High Altitude mode status	GET=HIGHALT<CR>	

Software specification

1. If the data is send but didn't send <CR> to finish the command in 5 seconds, it will timeout and need to resend command.
2. If the command format is illegal, it will echo "Illegal format".
3. If the command format is correct, but it is not valid for this model, it will echo "Unsupported item".
4. If the command format is correct, but can't be execute in some condition, it will echo "Block item".
5. Command interval need 2 – 3 sec during Lan standby

TIPS

- In low power, full power standby, warming up and cooling down if the command can't execute, it will always return "Block item".
- No case sensitive.
- If you turn the projector off after changing the IP address, the new settings will be reflected in the display 60 seconds after you next turn the projector on.

6. If using control commands to change aspect ratio, it will also close OSD menu.

Trademark Information

- Trademark PLink is a trademark applied for trademark rights in Japan, the United States of America and other countries and areas.
- HDBaseT and HDBaseT Alliance logo are trademarks of HDBaseT Alliance.
- DLP Cinema and the DLP Cinema logo are trademarks or registered trademarks of Texas Instruments.
- The terms HDMI and HDMI High-Definition Multimedia Interface, and the HDMI Logo are trademarks or registered trademarks of HDMI Licensing Administrator, Inc. in the United States and other countries.