



DU7099Z
DU7199Z
DU7299Z

User Manual

Table of Contents

1.General Information	5
Copyright.....	5
Disclaimer.....	5
Trademark Recognition.....	5
Important Safety Information.....	6
Symbols used	6
General Safety Information.....	6
Symbols used	6
Laser Warning.....	7
Class 3R Laser Product.....	7
Laser Parameter	7
Risk Group 3 Information	8
Warning Labels	9
Location of laser aperture.....	10
Interlock switches	10
General Notice.....	11
Power Supply	11
Cleaning the Projector	11
Regulatory Warnings	11
Symbol Explanations	11
Special Care for Laser Beams!	11
Sun Light Warning	11
2.Getting Started	12
Package Content	12
Projector Features	13
Projector Functions	13
Connect Source Devices.....	14
Control Keypad	14
Remote Controller (SRC) + Function	15
Set Control ID Number	16
Operating Range.....	17
Batteries	17
Installation Guide.....	18
Verify Installation Location	18
Cooling Notes	18
Installation Notice.....	19
Setup and Projection options.....	19
Mounting the Projector	20
Custom Stand Mount Installation compliances	20
Installing or Removing the Optional Lens.....	21
Lenses Series.....	22

Table of Contents

Projector Start Guide	23
1 Connect Power and Source Devices	23
2 Power ON/OFF	23
3 Select Source Device.....	23
4 Adjust Projector Tilt	24
Adjusting Projected Image Position Using Lens Shift.....	24
3.On-Screen Display (OSD) Menu Settings	25
OSD Menu Control	25
Navigating the OSD.....	25
INPUT Menu	26
Auto Source	26
HDMI.....	27
Analog.....	27
3D.....	27
Signal Power on	28
Test Pattern.....	28
PICTURE Menu	29
Picture Mode.....	30
Brightness	30
Contrast.....	30
Color Manager	30
Advanced	31
Picture Mode Reset.....	31
ALIGNMENT Menu	32
Aspect Ratio.....	33
Digital Zoom	33
Keystone.....	33
4 Corner	33
Masking	33
Projection	33
Screen Setting	33
Lens Settings	34
Alignment Reset.....	34
CONTROL Menu	35
Direct Power On.....	36
Light Source.....	36
High Altitude	36
IR Control.....	36
Remote ID.....	37
HDBaseT.....	37
Network.....	37
Art-Net Setup	43
Rental Mode	44

Table of Contents

SETTINGS Menu	45
Eco	46
Audio.....	46
Air Filter	46
Blank Screen Color	46
Menu	46
Keypad Lock	46
Security Lock	47
Language.....	47
Environment Status	47
Reset All.....	48
INFO Screen	48
4.Troubleshooting	49
Common Problems and Solutions.....	49
Troubleshooting Tips	49
LED Indicator Messages	50
Image Problems Q&A	51
Light Source Problems.....	51
Remote Control Problems.....	51
Audio Problems.....	52
Having the Projector Serviced	52
HDMI Q&A	53
5. Specifications	54
Projector Dimensions	54
Projector DataSheet.....	55
Projector Time Table	56
6. Regulatory Compliance	59
FCC Warning	59
Canada	59
Safety Certifications	59
Disposal and Recycling	59
7. RS-232 Communication	60
Communication parameter setup	60
Operation commands.....	60
Lens related function	68
8. Servies	69

1.General Information

Copyright

This publication, including all photographs, illustrations and software, is protected under international copyright laws, with all rights reserved. Neither this manual, nor any of the material contained herein, may be reproduced without written consent of the author. © Copyright 2023

Disclaimer

The information in this document is subject to change without notice. The manufacturer makes no representations or warranties with respect to the contents hereof and specifically disclaims any implied warranties of merchantability or fitness for any particular purpose. The manufacturer reserves the right to revise this publication and to make changes from time to time in the content hereof without obligation of the manufacturer to notify any person of such revision or changes.

Trademark Recognition



Kensington is a U.S. registered trademark of ACCO Brand Corporation with issued registrations and pending applications in other countries throughout the world.



HDMI, the HDMI Logo, and High-Definition Multimedia Interface are trademarks or registered trademarks of HDMI Licensing LLC in the United States and other countries.



HDBaseT™ and the HDBaseT Alliance logo are trademarks of the HDBaseT Alliance.

All other product names used in this manual are the properties of their respective owners and are acknowledged.

Important Safety Information

**Important:**

It is strongly recommended that you read this section carefully before using the projector. These safety and usage instructions will ensure that you enjoy many years of safe use of the projector. Keep this manual for future reference.

Symbols used

Warning symbols are used on the unit and in this manual to alert you of hazardous situations. The following styles are used in this manual to alert you to important information.

Note:

Provides additional information about the topic.

**Important:**

Provides additional information that should not be overlooked.

**Caution:**

Alerts you to situations that may damage the unit.

**Warning:**

Alerts you to situations that may damage the unit, create a hazardous environment, or cause personal injury.

Throughout this manual, component parts and items in the OSD menus are denoted in bold font as in this example:

“Push the **Menu** button on the remote control to open the **Main menu**.”

General Safety Information

- Do not open the unit case. There are no user-serviceable parts in the unit. For servicing, contact qualified service personnel.
- Follow all warnings and cautions in this manual and on the unit case.
- To avoid damage to eyes, do not look into the lens when the light source is on.
- Do not place the unit on an unstable surface, cart, or stand.
- Avoid using the system near water, in direct sunlight, or near a heating device.
- Do not place heavy objects such as books or bags on the unit.

Symbols used

This product is intended for the adults who have the ability to operate this machine.

Please write down your projector model number and serial number and keep the information for maintenance purposes in the future. Should the equipment be lost or stolen, the information could also be used for the police report.

Model number:

Serial number:

Laser Warning

Class 3R Laser Product

This Laser Product is designated as Class 3R during all procedures of operation.



LASER LIGHT - AVOID DIRECT EYE EXPOSURE.

Do not point laser or allow laser light to be directed or reflected toward other people or reflective objects .



Direct or scattered light can be hazardous to eyes and skin.

There is a potential hazard of eye exposure to laser radiation if the included instructions are not followed.

Caution – use of controls or adjustments or performance of procedures other than those specified herein may result in hazardous radiation exposure

Laser Parameter

Wavelength	449nm - 461nm (Blue)
Mode of operation	Pulsed, due to frame rate
Pulse width	1.12ms
Pulse repetition rate	120Hz
Maximum laser energy	0.611mJ
Total internal power	>100w
Apparent source size	>10mm, at lens stop
Divergence	>100 mili Radian

Risk Group 3 Information

Light hazard warning



Failure to comply with the following may result in serious injury:

- No direct exposure to the beam is permitted, RG3 IEC 62471-5:2015.
- Operators control access to the beam within the hazard distance or install the projector at sufficient height to prevent exposures of spectators' eyes within the hazard distance.

The hazard distance is the distance measured from the projection lens at which the intensity or energy per unit of surface is lower than the applicable exposure limit on the cornea or skin. If the person is within the hazard distance, the beam is considered unsafe for exposure.

The hazard distance for this projector is 0-150 cm.

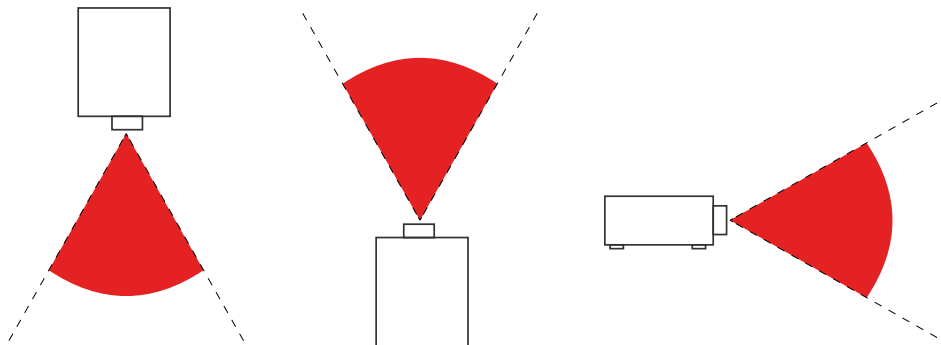

Note:

This projector is an RG3 product, which must be installed in a safe place and must be handled by qualified and professionally skill trained personnel

For the installation and removal of the lens, please consult your dealer with qualified professionals to install it. Do not try to install the projector yourself, otherwise your eyesight may be damaged

In case to install the projector over head, keep over 3m distance at least between the floor surface and the RG3 area. Operators shall control access to the beam within the hazard distance or install the product at the height that will prevent exposures of spectators' eyes within the hazard distance.

Warning Labels

Safety Hazard and Warning information Labels are placed at the following locations:



Hazard Warning Symbol and Aperture Label and Explanatory Label

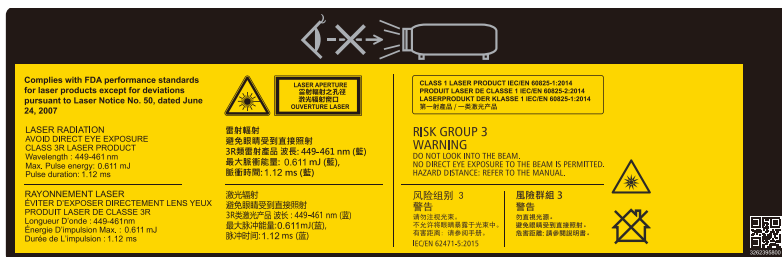

Location of laser aperture

Below drawing is the laser aperture location. Be careful not to let the eye see the light directly.

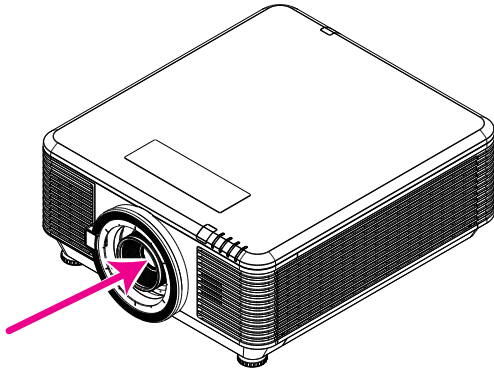

Laser aperture

Interlock switches

This machine has 2 (Top cover x 1, Lens x 1) Interlock switches to protect the laser light Leakage.

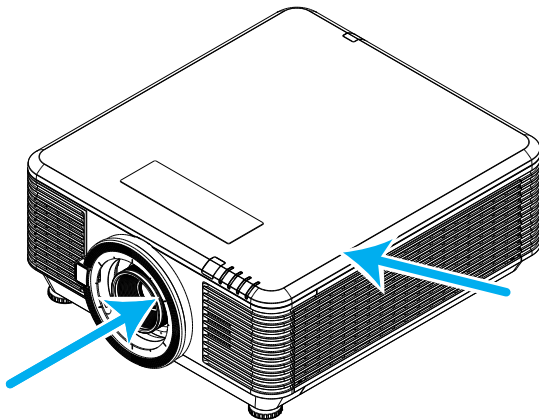

1. Will power-off the system individually when the top cover is removed.
2. Will power-off the system individually when the lens is removed or not install correctly.

General Notice

Power Supply

- Only use the supplied power cord.
- Do not place anything on the power cord. Place the power cord where it will not be in the way of foot traffic.
- Remove the batteries from the remote control when storing or not in use for a prolonged period.

Cleaning the Projector

- Unplug the power cord before cleaning.
- Allow the light source to cool for about one hour.

Regulatory Warnings

Before installing and using the projector, read the regulatory notices in the Regulatory Compliance on page [59](#).

Symbol Explanations



DISPOSAL: Do not use household or municipal waste collection services for disposal of electrical and electronic equipment. EU countries require the use of separate recycling collection services.

Special Care for Laser Beams!

Special care should be considered when DLP projectors and high power laser equipment are used in the same room as. Direct or indirect hit of a laser beam on to the projector lens can severely damage the Digital Mirror Devices (DMD™).

Sun Light Warning

Avoid using the series of projector in direct sun light. Sun light on the projector lens can severely damage the Digital Mirror Devices (DMD™).

2.Getting Started

Package Content

Carefully unpack the projector and check that the following items are included:

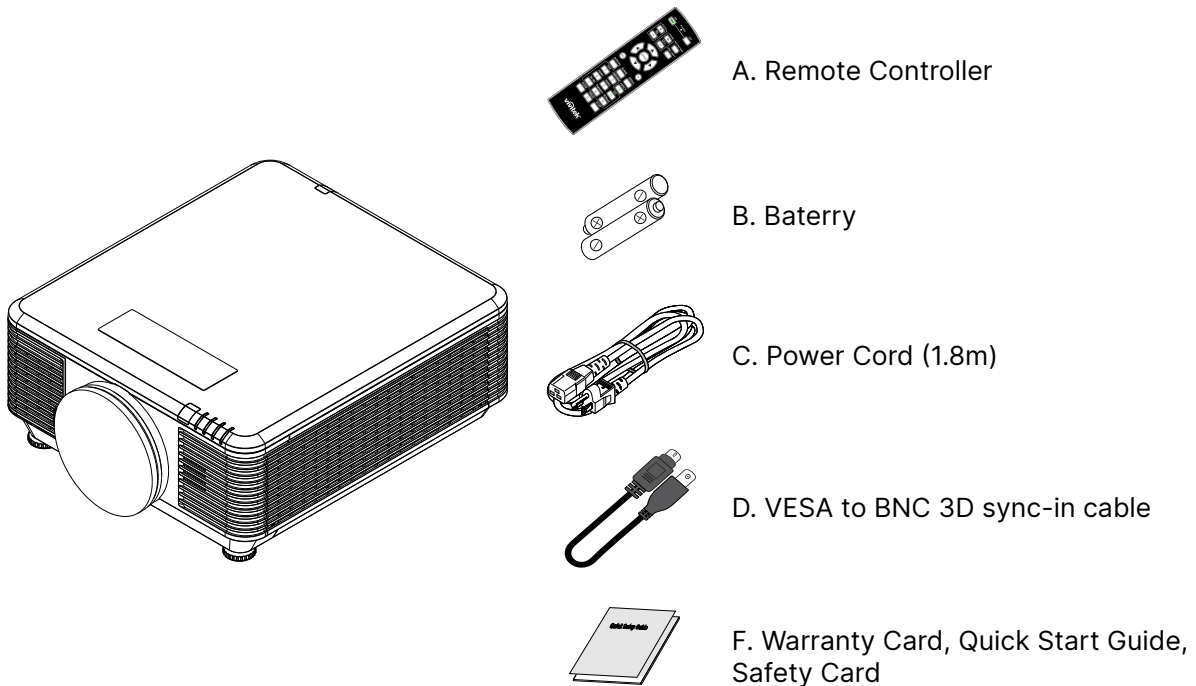

Note:

Contact your dealer immediately if any items are missing, appear damaged, or if the unit does not work. It is recommended that you keep the original packing material should you ever need to return the equipment for warranty service.



Caution:

Avoid using the projector in dusty environments.

Projector Features

- Compatible with all major video standards including NTSC, PAL, and SECAM
- A high brightness rating allows for presentations in daylight or in lit rooms
- Flexible setup allows for front, rear projections
- Line-of-vision projections remain square, with advanced keystone correction for angled projections
- Input source automatically detected
- High brightness for projection in just about any environment
- Supports resolutions up to 4K UHD for clear and crisp images
- DLP® and BrilliantColor™ technologies from Texas Instruments
- Centered lens for easy installation
- Horizontal and vertical lens shift
- Network ready for integration and system administration via RJ45
- Sealed engine to minimizing the impact of dust and smoke
- Anti-theft security features include: Kensington security slot, security bar
- Built-in HDBaseT receiver. HDBaseT™ interface with support for distribution of HD video, digital audio content RS232, RJ45 and IR function over standard CAT5e/6 LAN cable
- Advanced laser phosphor light engine for superior brightness and color uniformity
- Laser design deliveries up to 20,000 hours of operational time

Projector Functions

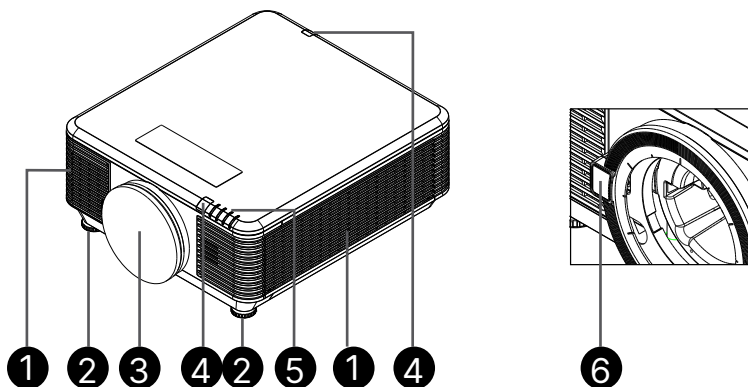

- | | |
|---|--|
| <ol style="list-style-type: none"> 1. Air Vents (inlet) 2. Tilt Foot 3. Lens Filter Sponge | <ol style="list-style-type: none"> 4. IR Receiver 5. LED Indicator 6. Lens Release Button |
|---|--|



Important:

Ventilation openings on the projector allow for good air circulation, which keeps the projector light source cool. Do not obstruct any of the ventilation openings.

Connect Source Devices

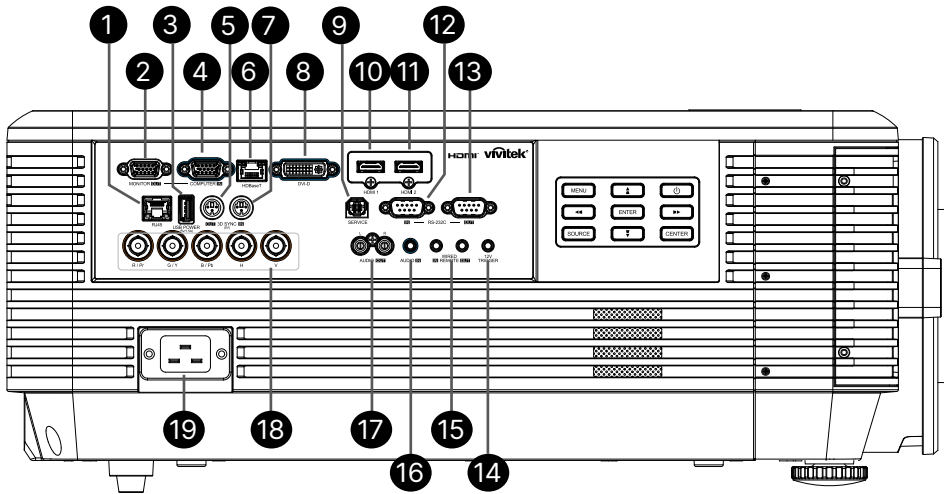

1. RJ45
2. MONITOR OUT
3. USB POWER (5V/1.5A)
4. COMPUTER IN
5. 3D-SYNC OUT (5V)
6. HDBaseT
7. 3D-SYNC IN (5V)
8. DVI-D
9. SERVICE
10. HDMI 1
11. HDMI 2
12. RS-232C IN
13. RS-232C OUT
14. 12V TRIGGER
15. WIRE REMOTE IN / OUT
16. AUDIO IN
17. AUDIO OUT L/R
18. BNC
19. AC IN

Control Keypad

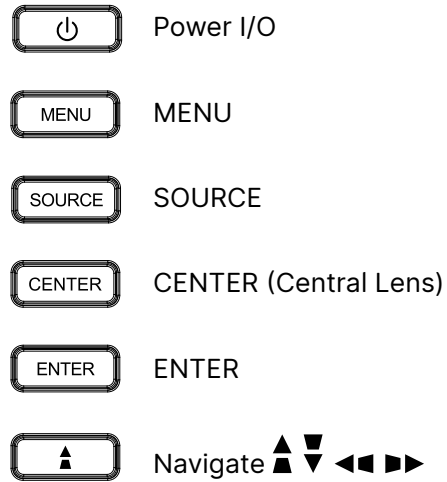

Note:

- To use this feature, you must plug in the connector before turn on/off the projector.
- Screen controllers are supplied and supported by screen manufacturers.
- Do not use this jack for anything other than intended use.



Warning:

As a safety precaution, disconnect all power to the projector and connecting devices before making connections.

Remote Controller (SRC) + Function

1. IR Transmitter
2. Power ON
3. Power OFF
4. ZOOM +
5. FOCUS +
6. FOCUS -
7. ZOOM -
8. TEST PATTERN
9. LENS SHIFT
10. Navigation
11. Menu
12. Exit
13. BLANK
14. AUTO PC
15. STATUS
16. ASPECT / ID 3
17. VGA / ID 1
18. COMPONENT / ID 2
19. HDMI1 / ID 4
20. HDMI2 / ID 5
21. 3G-SDI / ID 7 (Not Available)
22. Displayport / ID 8 (Not Available)
23. DVI / ID 6
24. HDBaseT / ID 9
25. CLEAR
26. Freeze / ID 0
27. ID SET
28. Wired Jack

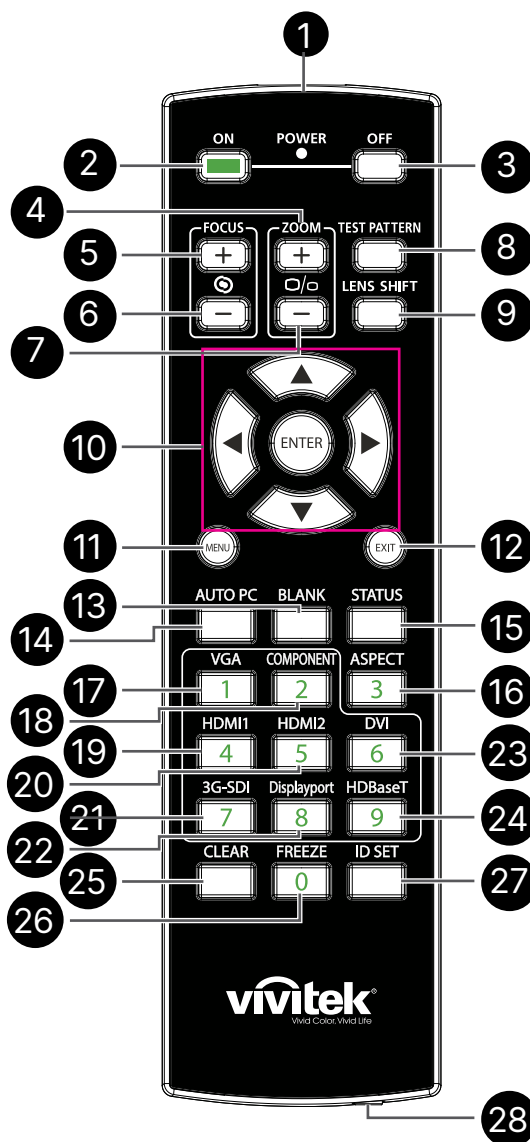

Important:

1. Avoid using the projector with bright fluorescent lighting turned on. Certain high-frequency fluorescent lights can disrupt remote control operation.

2. Be sure nothing obstructs the path between the remote control and the projector. If the path between the remote control and the projector is obstructed, you can bounce the signal off certain reflective surfaces such as projector screens.

3. The buttons and keys on the projector have the same functions as the corresponding buttons on the remote control. This user's manual describes the functions based on the remote control.

Set Control ID Number

Select Control ID Number option then press Enter button, use the ► button to increase the number or the ◀ button to decrease the number. This option is available when Projector ID Control is turned on.

Set the identification number of remote control

Press and hold ID SET button on the remote control around 5 seconds, Power LED indicator is flashing red periodically. Press two digits to set desired ID number, each pressing shall be leisurely. Power LED will flash on time when the remote control is confirmed the setting.

Press and Hold ID SET button Power LED is flashing around 5 seconds

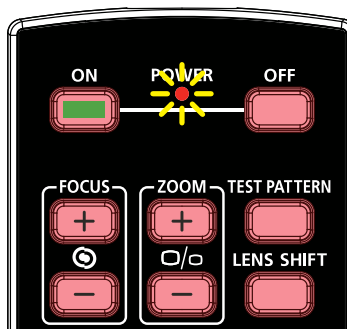

Press two digits for ID number



Note:

Setting the identification number will overwrite the ID number you had set. You can set the ID number directly if you would like to give a new ID number for the remote control.

Erase the identification number of the remote control

The set ID number is overwritten if new ID number is set, you can press ID SET and CLEAR button to erase ID number of the remote control.

Press ID SET and CLEAR buttons simultaneously

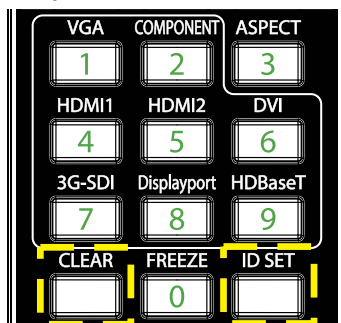

The backlight of the buttons is flashing one time

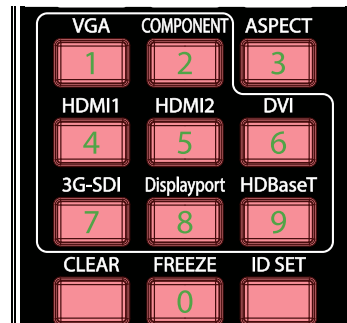

Operating Range

- The Remote Controller uses infrared transmission to control the projector.
- It is not necessary to point the remote directly at the projector.
- The Remote Controller will function properly within a distance radius of about 10 meters (25 feet) and vertical angle of 15 degrees above or below the projector level.

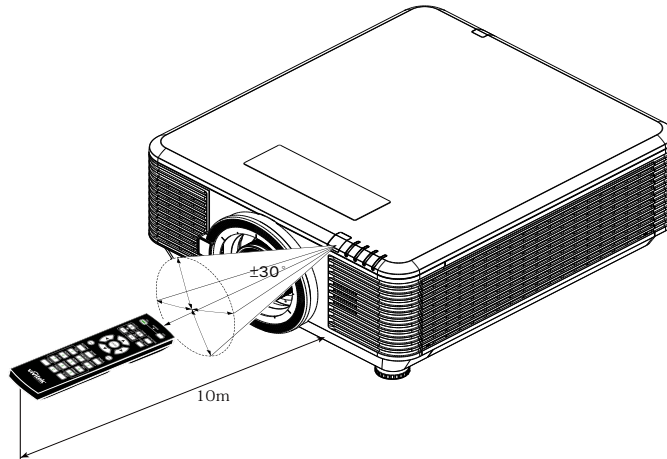
**Note:**

If the projector does not respond to the Remote Controller, Move to a closer range or Replace batteries.

Batteries

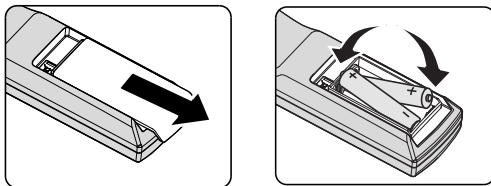

- Slide IN/OUT the battery compartment cover.
- Insert the battery with the positive side facing up.

**Caution:**

1. Only use AAA batteries (Alkaline batteries are recommended).
2. Dispose of used batteries according to local ordinance regulations.
3. Remove the batteries when not using the projector for prolonged periods.

Installation Guide

Verify Installation Location

- To supply power, use the 3-blade (with earthing lead) socket to ensure proper grounding and equalized ground potential for all Projector System equipments.
- Use the power cord provided with the Projector. In case the item is missing, use a qualified 3-blade (with earthing lead) power cord; DO NOT USE 2-BLADE POWER CORD.
- Verify that the voltage is stable, grounded properly and there is no electricity leakage.
- Measure the total power consumption and ensure it is within the safety capacity to avoid safety issue and short circuit.
- Turn on Altitude Mode when located in high altitude areas
- The projector can be installed and will function properly without limitation at any angle or orientation.
- Ensure installation brackets are firmly secured and can support the projector weight
- Avoid installing near air conditioner duct or sub-woofer.
- Avoid installing in locations with high temperature, insufficient cooling and heavy dust.
- Keep away from fluorescent lamps (>1 Meter) to avoid malfunction caused by IR interference
- Ensure the VGA IN connector is connected tightly to the VGA IN port. The screws on both sides securely fastened will secure the proper connection and wire signal to achieve optimal display.
- The AUDIO IN connector should only be connected to the AUDIO IN port. DO NOT connect to AUDIO OUT port or any other ports like BNC, RCA.
- Before you Power ON, ensure power cord and signal cable are connected properly. To avoid damaging the projector while starting and operating, DO NOT insert or remove the signal cable or the power cord.

Cooling Notes

Air Outlet

- Make sure the air outlet is 50cm clear of any obstruction to ensure proper cooling.
- Air outlet location should not be in front of the lens of other projector to avoid causing illusions.
- Keep the outlet at least 100cm away from the inlets of other projectors
- The projector generates a massive amount of heat during use. The internal fan dissipates the heat of the projector when shutting down, and such process may continue for a certain period. After the project enters STANDBY MODE status, press the AC power button to turn off the projector and remove the power cord. DO NOT remove the power cord during the shut-down process, as it may cause damage to the projector. In the meantime, the delayed heat radiating will also affect the service life of the projector. The shut-down process may vary depending on the model used. Whatever the case may be, make sure to disconnect the power cord till after the projector enters the STANDBY status.

Air Inlet

- Make sure there is no object blocking air input within 30 cm.
- Keep the inlet away from other heat sources
- Avoided heavy dust area

Installation Notice

- There is no limitation angle for projector installation

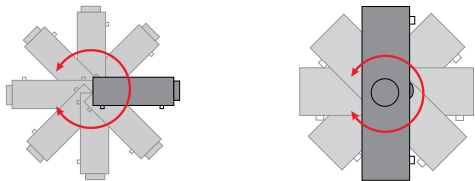

- Insure a minimum clearance space of > 500mm (19.7 inch) around all exhaust vents.

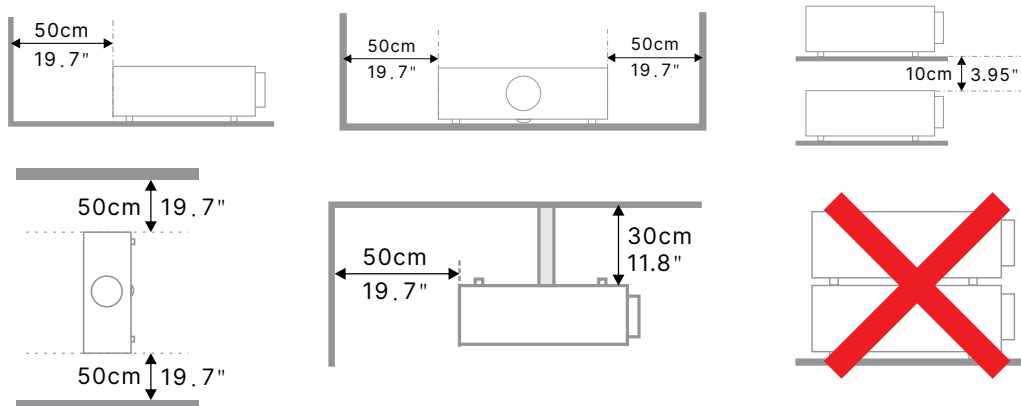

- When operating the projector in an enclosed space, ensure that the surrounding air temperature does not exceed the maximum allowed operating temperature and that all air intake and exhaust vents are unobstructed.

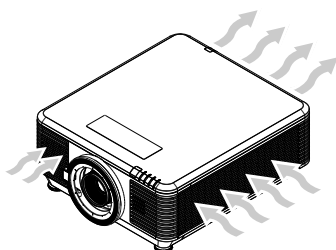

- Ensure that the intake vents do not recycle hot air or exhaust air from the exhaust vents as this may cause the device to shut-down even if the enclosure temperature is within the acceptable operating temperature range.
- All enclosures should pass a certified thermal evaluation to ensure that the projector does not recycle exhaust air.

Setup and Projection options

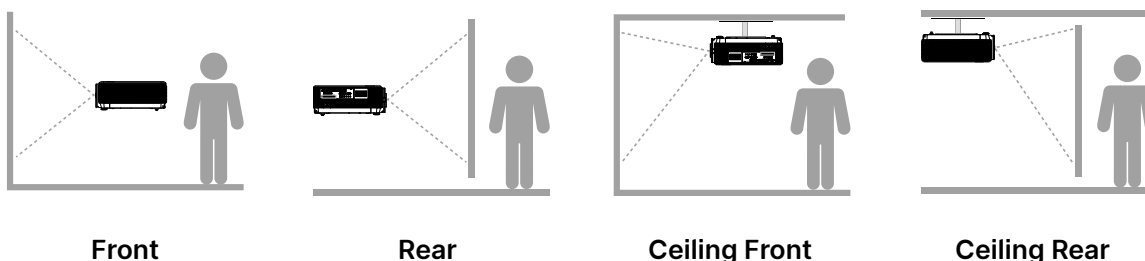

Front

Rear

Ceiling Front

Ceiling Rear

Mounting the Projector

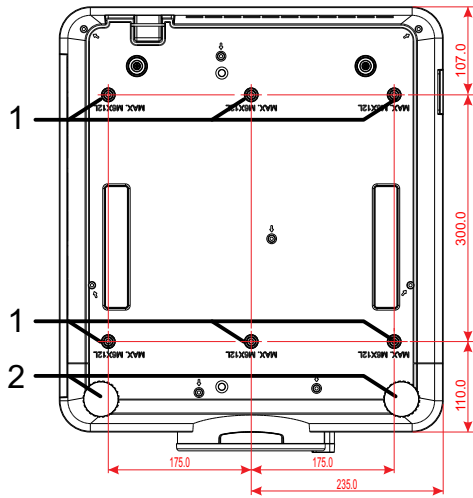

Caution: When installing, ensure that you use only UL Listed ceiling mounts.

For ceiling installations, use approved mounting hardware and M6 screws with a maximum screw depth of 12mm (0.47 inch).

The construction of the ceiling mount must be of a suitable shape and strength. The ceiling mount load capacity must exceed the weight of the installed equipment, and as an additional precaution be capable of withstanding three times the weight of the equipment over a period of 60 seconds.

Custom Stand Mount Installation compliances

For custom design mount installation such as portait, Please comply to the following :

- Use 6 screws to securely anchor the projector to the mount.
- Screw hole center dimension: 300 × 350 (pitch = 175) mm
- Ensure a sturdy base design to support the projector weight and avoid toppling over.

Note:

The drawing showing below is for referal only. It is not an accurate stand design drawing.

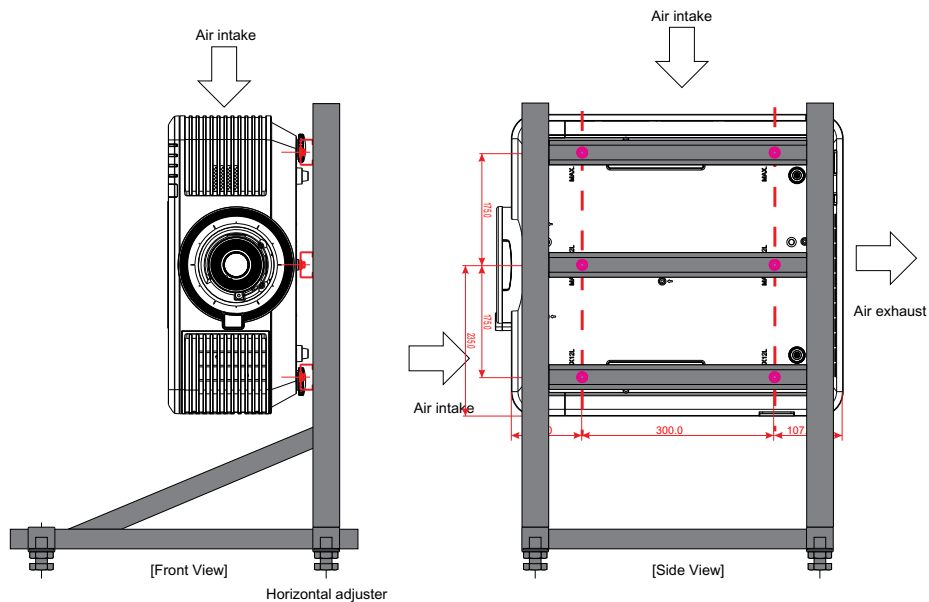

Installing or Removing the Optional Lens



Caution:

1. Do not shake or place excessive pressure on the projector or the lens components as the projector and lens components contain precision parts.
2. Before removing or installing the lens, be sure to turn off the projector, wait until the cooling fans stop, and turn off the main power switch.
3. Do not touch the lens surface when removing or installing the lens.
4. Keep fingerprints, dust or oil off the lens surface.
5. Do not scratch the lens surface.
6. Work on a level surface with a soft cloth under it to avoid scratching.
7. If you remove and store the lens, attach the lens cap to the projector to keep off dust and dirt.

Installing the New Lens

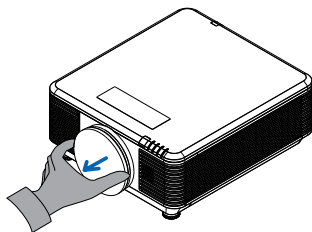

Please take off lens filter sponge.

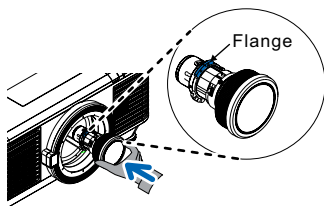

Align the flange and correctly position as shown in the picture.

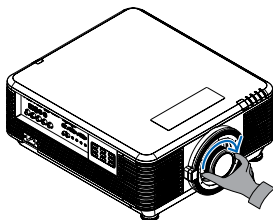

Rotate the lens clockwise until you feel it click into place.

Removing the Existing Lens From the Projector

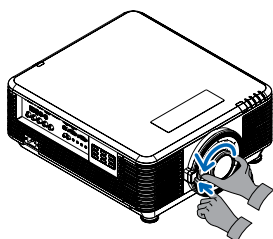

Push the LENS RELEASE button to the unlock position.

Grasp the lens.

Rotate the lens counterclockwise.
The existing lens will be disengaged.

Pull out the existing lens slowly.

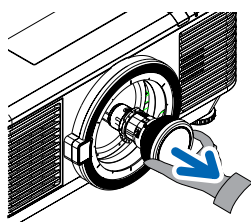

Lenses Series

Eight types of optional electric lenses are available for the projector as below table. Contact the authorized dealer of Vivitek for details.

Lenses Group (Optional)

Lens	Throw Ratio	Zoom Ratio	Image Size (Diagonal)	Projection Distance
Short Throw Zoom D86-0711	0.77 - 1.1	1.42x	42.3"~300"	1 – 4.98m
Standard Short Throw D86-1113	1.1 - 1.3	1.18x	35.8" - 379.8"	1 – 9m
Semi Short Throw D86-1216	1.25 -1.60	1.28x	39.1"~300"	1.35 – 8.08m
Standard D86-1519	1.54 - 1.93	1.25x	48.2"~300"	2 – 10m
Long Throw D86-1929	1.93 - 2.9	1.5x	32.1" - 481.1"	2.0 – 20m
Semi Long Zoom D88-SMLZ01	2.22 -3.67	1.65x	40"~500"	1.05 – 19.59m
Long Zoom D88-LOZ101	3.58 - 5.38	1.5x	40"~500"	1.05 – 19.59m
Long Zoom D88-LOZ201	5.31- 8.26	1.55x	40"~500"	1.05 – 19.59m

Note:

The best performance of above zoom lenses is within vertical shift -40%~50%, horizontal shift $\pm 13\%$, the projector may support to wider adjustable shift range for flexibility in installation.

Projector Start Guide

1 Connect Power and Source Devices

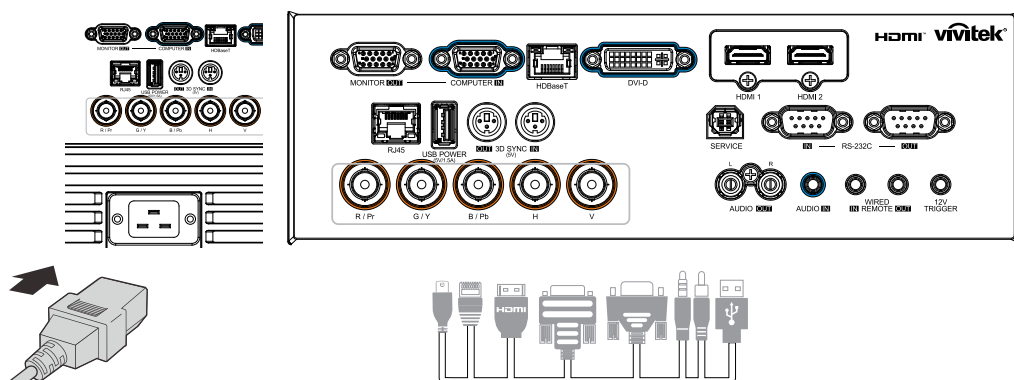

- Securely connect the provided power cord and your Source Devices. (HDMI, USB, VGA, RJ45, Computer, HDBaseT, etc.)
When connected, the power led will flash green to solid green.

2 Power ON/OFF

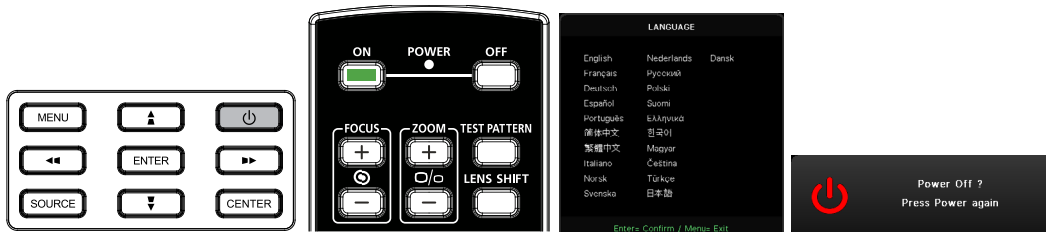

- Turn ON: Press on the projector or **ON** the remote controller. The PWR LED will now flash green. The startup screen will display in approximately 30 seconds.
- The first time you Turn ON the projector, you can select your preferred language. see Setting Language on page 47.
- Turn OFF: Press on the projector or **OFF** on the remote controller. The message “Power Off? /Press Power again” will appears on-Screen Press the POWER button again to confirm the projector Turn OFF.

3 Select Source Device

- Press the **SOURCE** button and use to scroll through the Source Devices.
- Press to select the Source Device.

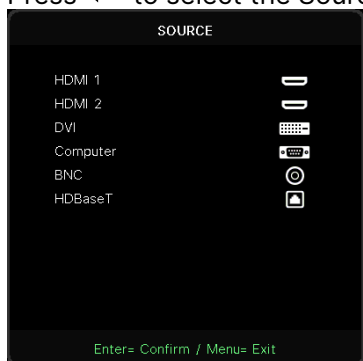



Note:

Component is supported through the RGB to Component adapter.

Using a single HDBaseT CAT5e (above) cable, the projector supports an HDBaseT connection distances to 100m/328ft.

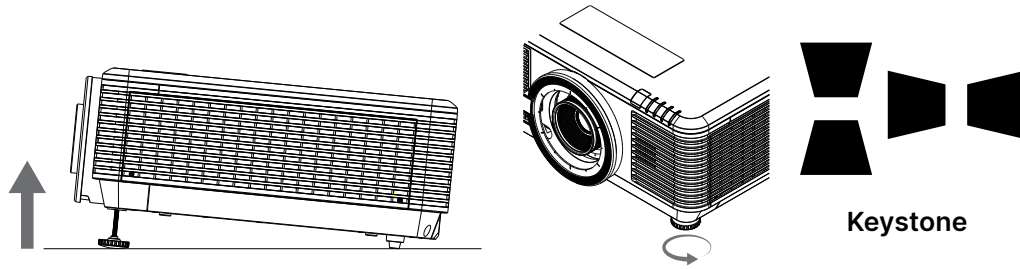
4 Adjust Projector Tilt



- To Raise the Tilt angle, Rotate counter clockwise both Left and Right Tilt foot.
- Press KEYSTONE button to adjust the Screen Tilt. The Keystone control appears on the display. Press  for V Keystone correcting image. Press  for H Keystone correcting image.

Caution: When setting up the projector

1. The projector table or stand should be level and sturdy.
2. Position the projector so that it is perpendicular to the screen.
3. Ensure the cables are in a safe location. You could trip over them.

Adjusting Projected Image Position Using Lens Shift

The projector has the powered lens shift feature; the image can be shifted vertically or horizontally without moving the projector. The lens shift range is shown in the percentage of the image height and width, the maximum vertical shift range can be up to 70% of the image height and down to 50% of the image height, and maximum horizontal shift range is 15% of the image width to right and left. Please refer to below illustration.

Lens Shift Range Diagram

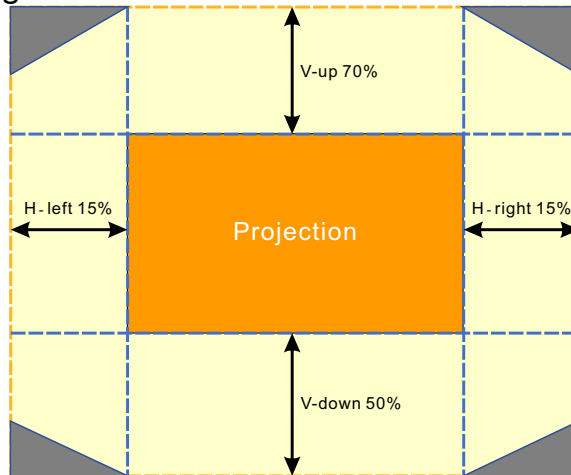

The  area is the Boundary of Lens Shift

Note: The projector is equipped with a safety switch inside the lens mount hole. The projection lens must be installed in the projector before turning on the power or the projection can't be started.

There is a Lens Lock function on OSD menu to disable lens control adjustment for avoiding possible misoperation after you finish the adjustment. Please make sure to disable the lock before performing the lens control.

3.On-Screen Display (OSD) Menu Settings

OSD Menu Control

The On-Screen Display (OSD) lets you make image adjustments, change various settings and check the projector's current status.

Navigating the OSD

You can use the remote control or the control buttons on the projector to navigate and make changes to the OSD.

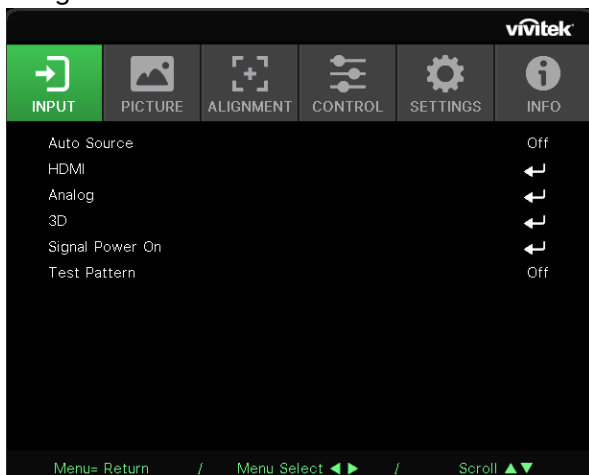

- To enter the OSD, press the MENU button.
- There are six top menus icons. Press ◀ / ▶ buttons to select menus.
- Press ▼/▲ buttons to scroll through the submenus.
- Press ◀ / ▶ buttons to change the submenus settings.
- Press ↵ to enter the advanced submenus settings
- Press the MENU button to close the OSD or leave a submenu.
- Press the EXIT button to return to the previous menu.

Note:

Depending on the video source, not all items in the OSD are available. For example, the Horizontal/Vertical Position items in the Computer menu can only be modified when connected to a PC. Items that are not available cannot be accessed and are grayed out.

INPUT Menu



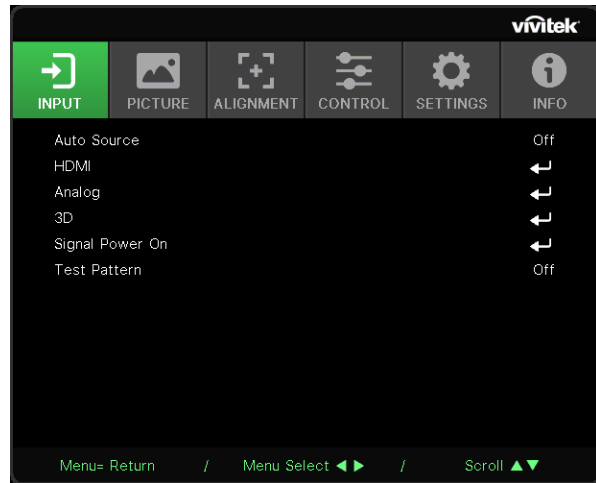





Auto Source	On, Off
HDMI	HDMI Format: Auto, RGB Limited, RGB Full, YUV Limited, YUV Full
	HDR: Auto, Off, HDR 10
	HDMI EDID: HDMI1, HDMI2
Analog	H Position: -5~5
	V Position: -5~5
	Phase: 0~31
	Phase: 0~31
	Auto Sync: On, Off
3D	3D: DLP-Link, IR
	3D Sync Invert: Off, On
	3D Format: Auto, Top, Bottom, Frame Sequential, Frame Packing, Side By Side, Off
	3D Sync Out Delay: 0 ~ 359
	3D Sync Output: Internal, External
Signal Power on	Computer: Off, On
	HDMI: Off, On
Test Pattern	Grid, White, Red, Green, Blue, Black, RGB Ramps, Color Bar, Step Bar, Check-Board, Horizontal Lines, Vertical Lines, Diagonal Lines, Horizontal Ramps, Vertical Ramps, Off















Auto Source

- Use ◀▶ to set On/Off.
- **On:** Lets projector searching for the input signal automatically.
- **Off:** Select the input signal manually.

















HDMI

- Press  and use / to scroll through submenus.
- **HDMI Format:** Set HDMI Format.
Auto: According to HDMI Info Frame to detect color space automatically.
RGB Limited: Force to select RGB limited range color space.
RGB Full: Force to select RGB full range color space.
YUV Limited: Force to select YUV limited range color space.
YUV Full: Force to select YUV full range color space
- **HDR:** Use / to set Auto, Off, HDR 10.
Auto: Switch to HDR setting automatically when detecting HDR sync.
Off: No matter detect HDR sync or not , force to close HDR settings .
HDR 10: No matter detect HDR sync or not , force to select HDR settings
- **HDMI EDID:** Press  and use / to set HDMI1, HDMI2
Enhanced: Select to use HDMI 2.0 EDID.
Standard: Select to use HDMI 1.4b EDID.

Analog

- Press  and use / to scroll through submenus.
- **H Position:** Use / to adjust the display position in horizontal direction.
- **V Position:** Use / to adjust the display position in vertical direction.
- **Phase:** Use / to adjust the frequency to reduce analog RGB image distortion.
- **Clock:** Use / to adjust the horizontal width of the analog RGB image.
- **Auto Sync:** Use / to select On/Off to lock image sync.

3D

- Press  and use / to set 3D source, sync method and 3D format.
- Before performing 3D setting, make sure that the input signal with 3D sync is connected.
- **3D:** Use / to enable or disable 3D functions.
DLP-Link: Enable internal 3D sync.
IR: Enable external 3D sync.
- **3D Sync Invert:** Use / to swap the 3D signal L/R or R/L.
On: Enable inverse signal.
Off: Follow received signal sync.
- **3D Format:** Press  and use / to select 3D format type :
Auto, Top, Bottom, Frame Sequential, Frame Packing, Side By Side, Off.
- **3D Sync Input Delay:** Use / to adjust delay the Input 3D sync.
- **3D Sync Out Delay:** Use / to adjust delay the output 3D sync.
- **3D Sync Output:** Use / to select 3D format type :
Internal: 3D Sync is from internal sync generator.
External: 3D Sync is from external input connector.



Important:

People with the following conditions should view 3D image with great care:

Children under six years in age.







People who are sensitive to light or allergic to light, unhealthy and have a history of cardiovascular diseases.

People who are tired or lack of sleep.



People who are under the impact of drugs or alcohol.

Normally, it is safe to watch 3D images. However, some people might feel uncomfortable. Refer to the guidelines that were revised and released by the 3D League on December 10, 2008. It states that those who watch 3D images, need to take a break for at least 5 to 15 minutes every thirty minutes or one hour.

Signal Power on

- Press  and use / to scroll through submenus.
- **Computer:** Use / to set On/Off to enable or disable auto Power On by VGA input.
- **HDMI:** Use / to set On/Off to enable or disable auto Power On by HDMI input.

Test Pattern

- Use / to select Grid, White, Red, Green, Blue, Black, RGB Ramps, Color Bar, Step Bar, CheckBoard, Horizontal Lines, Vertical Lines, Diagonal Lines, Horizontal Ramps, Vertical Ramps, Off to enable the test pattern image.

PICTURE Menu

Picture Mode	Presentation, Bright, Game, Movie, Vivid, Blending, sRGB, DICOM SIM, User, (3D), (HDR 10)
Brightness	0~100
Contrast	0~100
Color Manager	Color: R, G, B, C, M, Y, W
	Hue: -99~99 Red : 0~399 (only W)
	Saturation: 0~199 Green : 0~399 (only W)
	Gain: 5~195 Blue : 0~399 (only W)
Advanced	Brilliant Color: 0~10
	Sharpness: 0~31
	Gamma: 1.8, 2.0, 2.2, 2.4, B&W, Linear, DICOM SIM
	HDR PQ: PQ-L300, PQ-L400, PQ-L500, PQ-L600, PQ-L700 (for HDR only)
	Color Temperature: Warm, Normal, Cold
	Input Balance: R Gain, G Gain, B Gain, R Offset, G Offset, B Offset
Picture Mode reset	Current: (OK, Cancel)
	All: (OK, Cancel)

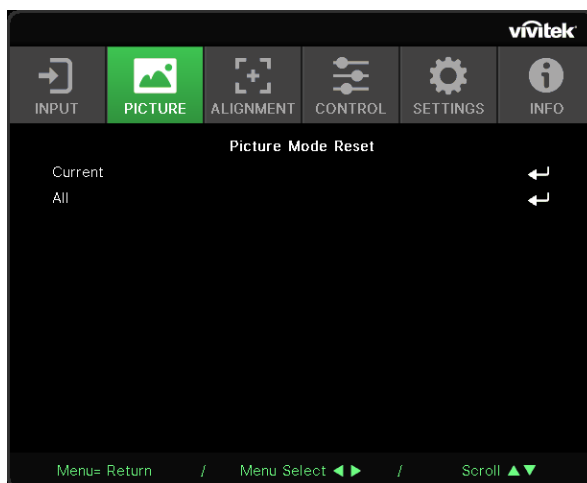
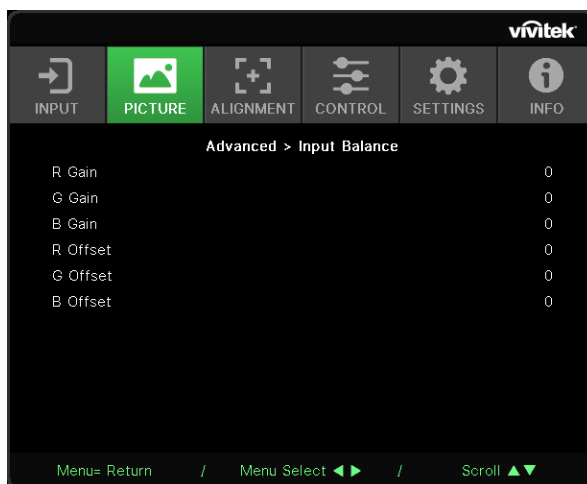
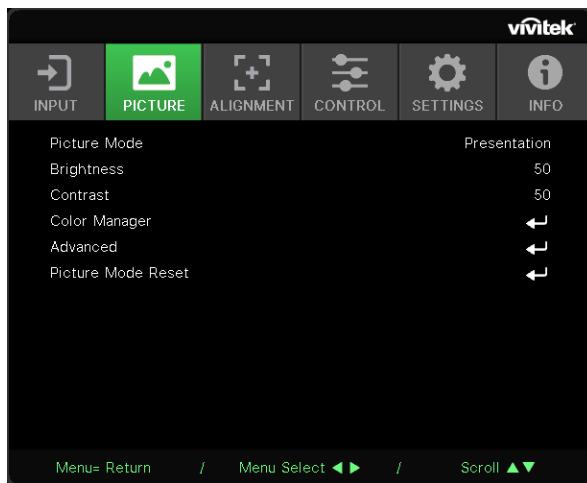

Picture Mode

- Use ◀/▶ to select a mode according to personal preference.
- **Presentation:** Suggest to use. The best projection effect for presentation.
- **Bright:** The mode is suitable for the application environment where is needed with highest brightness output .
- **Game:** Using for video game.
- **Movie:** To provide good balance of color saturation, contrast and brightness. Suggest to use in a dark environment.
- **Vivid:** To provide Vivid colors.
- **Blending:** The mode is suitable for immersive environment.
- **sRGB:** Optimization RGB colors to reach true-to-life images with limited brightness setting.
- **DICOM SIM:** To use for Digital Imaging and Communications in Medicine.
- **User:** Personalization with preference of Brightness, Contrast, Color.
- **3D:** Automatically switch when detecting 3D sync.
- **HDR 10:** Automatically switch when detecting HDR sync.

Brightness

- Use ◀/▶ to increase or decrease the brightness level of the image.

Contrast

- Use ◀/▶ to adjust the contrast level of the image.

Color Manager

- Press ↵ and use ▼/▲ to scroll through submenus.
- **Color:**To select and adjust the color(Red,Green,Blue,Cyan,Magenta,Yellow, White).
- **Hue:** Use ◀/▶ to adjust the Color Hue value.
- **Saturation:** Use ◀/▶ to adjust the Color Saturation value.
- **Gain:** Use ◀/▶ to adjust the Color Gain value.
- **Red:**Use ◀/▶ to adjust the White Color's Red value.
- **Green:**Use ◀/▶ to adjust the White Color's Green value.
- **Blue:**Use ◀/▶ to adjust the White Color's Blue value.
- These three options are used to adjust the range of color input for the entire image. If minimal amount of red, green or blue appears in the gray areas, lower the gain of the corresponding color accordingly. As gain increases, the contrast of the image will become lower.

Advanced

- Press **↵** and use **▼/▲** to scroll through submenus.
- **Brilliant Color:** Use **◀/▶** to adjust the brilliant color of image.
- **Sharpness:** Use **◀/▶** to adjust the sharpness of image.
- **Gamma:** Use **◀/▶** to select the different chrominance of image.
When the ambient light is so bright that may affect the projection image in the dim area. , you can change the gamma to adjust the chrominance. The available options are 1.8, 2.0, 2.2, 2.4, B&W, Linear, DICOM SIM.
- **HDR PQ:** Use **◀/▶** to select PQ settings PQ-L300, PQ-L400, PQ-L500, PQ-L600, PQ-L700.
- **Color Temperature:** Use **◀/▶** to select the color temperature.
Warm : Make image reddish white.
Normal : Normal colorings of white.
Cold : Make image bluish white.
- **Input Balance:** Press **↵** and use **▼/▲** to scroll through submenus.
Use **◀/▶** to adjust Gain and Offset values of Red ,Green ,Blue color for white balance.
Gain: Adjust the brightness level of Red ,Green,Blue.
Offset: Adjust the contrast level of Red, Green,Blue.

Picture Mode Reset

- Press **↵** and use **▼/▲** to scroll through submenus.
- **Current:** Press **↵** to reset current Picture Mode to the default settings.
- **All:** Press **↵** to reset all Picture Mode to the default settings.

Note:

"Picture Mode Reset" is only reset according to input signal.

ALIGNMENT Menu

Aspect Ratio	Fill, 4:3, 16:9, Letter Box, 2.35:1, 16:10, Auto
Digital Zoom	Zoom In: 0~10 (1.0x~2.0x) Zoom Out: -40~0 (0.8x~1.0x) Image Shift: H Image Shift, V Image Shift
Keystone	V Keystone: -30~0~30 H Keystone: -30~0~30
4 Corner	Corner: Top-Left, Top-Right, Bottom-Left, Bottom-Right H: 0~60 V: 0~60
Masking	Top: 0~100 Bottom: 0~100 Left: 0~100 Right: 0~100
Projection	Front, Rear, Front+ Ceiling, Rear+ Ceiling
Screen Setting	Screen Format: 16:10, 16:9, 4:3, 2.35:1 Screen Position: Grey Out, -60~0~60(When 16:9), -160~0~160(When 4:3), -191~0~191(When 2.35:1)
Lens Settings	Lens Lock: Off, On Lens Type: non-UST Lens, UST Lens Lens Control: Zoom & Focus, Lens Shift Lens Memory: Save , Load Memory : 1~10 Center Lens (execute)
Alignment Reset	(OK, Cancel)

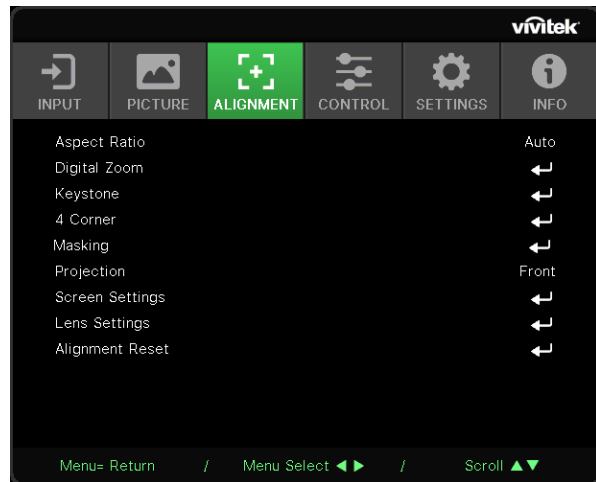

Aspect Ratio

- Use ◀/▶ to select the image aspect ration (Fill ,4:3 ,16:9 or 16:10 , Letter Box ,2.35:1, Auto)

Digital Zoom

- Press ↵ and use ▼/▲ to scroll through submenus.
- **Zoom In:** Use ◀/▶ to make the image seem to large the content from 0~10 value.
- **Zoom Out:** Use ◀/▶ to make the image seem to small the image from 0~-40 value. Adjust Zoom Out will reset HV image shift to default value.
- **Image Shift:** Press ↵ and use ▼/▲ to scroll through submenus.
H Image Shift: Use ◀/▶ to Shift the image Horizontally (left / right).
V Image Shift: Use ◀/▶ to Shift the image Vertically (up / down).
Depend on Zoom Out, not fixed.

Keystone

- Press ↵ and use ▼/▲ to scroll through submenus.
- **V Keystone:** Use ◀/▶ to adjust the value to correct the image Vertical distortion. The adjustable value is ± 30 .
- **H Keystone:** Use ◀/▶ to adjust the Horizontal distortion of image. The adjustable value is ± 30 .

4 Corner

This function is used to correct the image distortion that may occur in a corner due to installation or projected surface.

- Press ↵ and use ▼/▲ to scroll through submenus.
- **Corner:** Use ◀/▶ to select a corner (Top Left, Top Right, Bottom Left, Bottom Right).
- **H:** Use ◀/▶ to increase or decrease the Horizontal value.
- **V:** Use ◀/▶ to increase or decrease the Vertical value.

Masking

- Press ↵ and use ▼/▲ to scroll through submenus.
- **Top:** Use ◀/▶ to adjust Masking function on the screen from Top side, Bottom side, Left side and Right side value.





















Projection

- Use ◀/▶ to select the Projection position.
- **Front:** Install the projector on the desktop and project the image forward.
- **Rear:** Install the projector on the desktop and project the image from the rear of the screen.
- **Front Ceiling:** Mount the projector on the ceiling and project the image forward.
- **Rear Ceiling:** Mount the projector on the ceiling and project the image from the rear of the screen.

Screen Setting

- Press ↵ and use ▼/▲ to scroll through submenus.
- **Screen Format:** Use ◀/▶ to select the screen format to 16:10, 16:9, 4:3 and 2.35:1.
- **Screen Position:** Use ◀/▶ to adjust the Position of Screen.

Lens Settings

- Press  and use / to scroll through submenus.
- **Lens Lock:** Use / to adjust the Lens Lock to On or Off.
- **Lens Type:** Use / to adjust the Lens Type to non-UST Lens, UST Lens.
- **Lens Control:** Use / to adjust Lens Focus. Use / to adjust Lens Zoom. Press Enter to switch Lens Shift menu. Press /// to adjust Lens Shift. Press Enter to switch Lens Control menu.
- **Lens Memory:** Press  and use / to scroll through submenus.
Save Memory: Press  to select the memory set for storing the setting then press ENTER button to confirm.
Load Memory: Press  to select the desired memory setting then press ENTER button to execute the lens setting, the projector will adjust the Lens position, Zoom and Focus automatically.
- **Center Lens:** Press  to do Lens Shift central calibration.

Alignment Reset

- Press  to reset all Alignment to the default settings.

CONTROL Menu

Direct Power On	Off, On
Light Source	Light Mode: Normal, ECO, Custom Light
	Custom Light: 25~100
	Constant Brightness: Off, On
	ViviBlack: Dynamic Black, Light Off Timer
High Altitude	Normal, High
IR Control	Front+ Rear IR On, Front IR On, Rear IR On, Front+ Rear IR Off
Remote ID	Default~99
HDBaseT	HDBaseT-IR_RS232_RJ45: Off, On
	HDBaseT EDID: Enhanced, Standard
Network	Network State: Connect, Disconnect
	DHCP: Off, On
	IP Address: 0~255, 0~255, 0~255, 0~255
	Subnet Mask: 0~255, 0~255, 0~255, 0~255
	Gateway: 0~255, 0~255, 0~255, 0~255
	DNS: 0~255, 0~255, 0~255, 0~255
Apply: OK, Cancel	

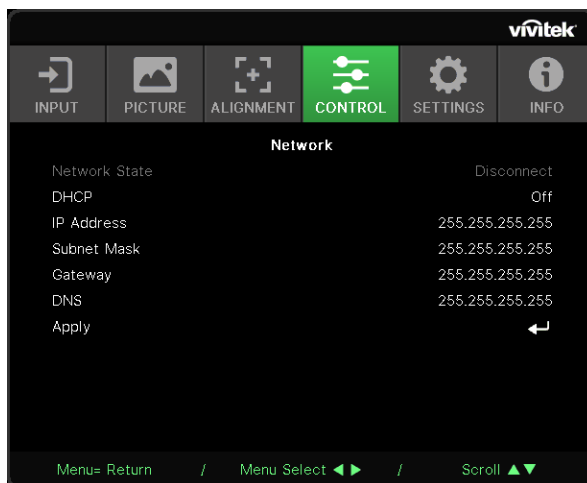
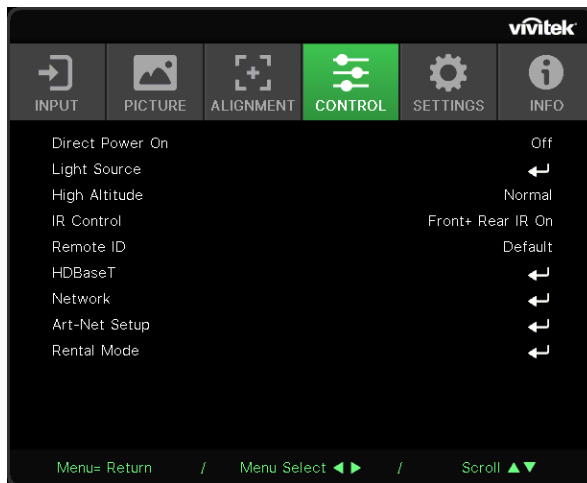

Art-Net Setup	Art-Net Enable: Off, On (2.X.X.X), On (10.X.X.X), On (Manual)
	Net: 0~127
	Sub Net: 0~15
	Universe: 0~15
	Universe: 0~15
	Apply: (OK, Cancel)
	Art-Net Channel Settings: Channel 1, Channel 2, Channel 3, Channel 4, Channel 5

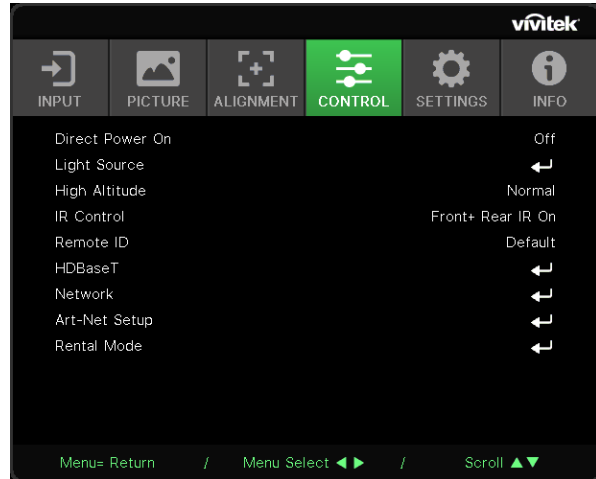

Rental Mode	Power Locked Level : 60~100 Power Locked Level Reset
	Usage Locked Time : Disable, Enable Usage Locked Settings (HRS) : 1~9999 Expiration Time Reset
	Change Password: New Password, Confirm Password

Direct Power On

- Use ◀/▶ to switch On/Off.
This function is set to Off by default. When it is set to On, the projector will turn on automatically when the AC power is turned on the next time. You can use this function and the power switch (instead of the remote control) to turn on the projector.

Light Source

- Press ↵ and use ▼/▲ to scroll through submenus.
- **Light Mode:** Use ◀/▶ to select (Normal, Eco, Custom Light).
- **Custom Light:** Use ◀/▶ to adjust brightness level between 25% to 100%.
- **Constant Brightness:** Use ◀/▶ to switch On/Off.
- **ViviBlack:** Press ↵ and use ▼/▲ to scroll through submenus.
Dynamic Black: Use ◀/▶ to switch On/Off.
Light Off Timer: Use ◀/▶ to select light-off time(Disable, 1 Sec./ 2 Sec., 3 Sec., 4 Sec.).

High Altitude

- Use ◀/▶ to adjust cooling fan speed (Normal, High).

IR Control

- Use ◀/▶ to select the preferred IR control location (Front+ Rear IR On, Front IR On, Rear IR On, Front+ Rear IR Off).
This function let you select which IR remote controller receiver is active.

Remote ID

Display current projector ID and remote control ID number. To set a unique ID for the projector and control independently.

HDBaseT

- Press **↵** and use **▼/▲** to scroll through submenus.
- **HDBaseT-IR_RS232_RJ45**: Use **◀/▶** to switch HDBaseT-IR_RS232_RJ45 On/Off Enable the control function of HDBaseT with IR, RS232 and RJ45.
- **HDBaseT EDID**: Use **◀/▶** to select HDBaseT mode (Enhanced, Standard).

Note:

If HDBaseT control set to On, Low power mode will set to "On by HDBaseT", and disable this function to select.

Network

Use this function to configure the network settings, so that you can control the projector via the network.

- Press **↵** and use **▼/▲** to scroll through submenus.
- **Network State**: Connect / Disconnect the network automatically.
- **DHCP**: Use **◀/▶** to Set DHCP to On/Off.
When DHCP is set to On, the DHCP server of the domain will assign an IP address to the projector. The IP address will appear on the IP address window without applying any input. If the domain cannot assign any IP address, 0.0.0.0 will be shown on the IP address window.
- **IP Address**: Press **↵** to show the IP address input window.
Use **◀/▶** to select the number in the address to change.
Use **▼/▲** to increase or decrease the number in the IP address.
(Example :Network IP Address 172. xxx. xxx. xxx.)
- **Subnet Mask**: Set the subnet mask. The input method is the same as the setting for IP address.
- **Gateway**: Set the gateway. The input method is the same as the setting for IP address.
- **DNS**: Set the DNS. The input method is the same as the setting for IP address.
- **Apply**: Press **↵** and use **▼/▲** to scroll through submenus.

Wired LAN Terminal functionalites

Remote control and monitoring of a projector from a PC (or Laptop) via wired LAN is also possible. Compatibility with Crestron / AMX (Device Discovery) / Extron control boxes enables not only collective projector management on a network but also management from a control panel on a PC (or Laptop) browser screen.

- Crestron is a registered trademark of Crestron Electronics, Inc. of the United States.
- Extron is a registered trademark of Extron Electronics, Inc. of the United States.
- AMX is a registered trademark of AMX LLC of the United States.
- PJLink applied for trademark and logo registration in Japan, the United States of America, and other countries by JBMIA.

Supported External Devices

This projector is supported by the specified commands of the Crestron Electronics controller and related software (ex, RoomView ®).

<http://www.crestron.com/>

This projector is supported by AMX (Device Discovery).

<http://www.amx.com/>

This projector is compliant to support Extron device(s) for reference.

<http://www.extron.com/>

This projector supports all commands of PJLink Class1 (Version 1.00).

<http://pjlink.jbmia.or.jp/english/>

For more detail of information about the diverse types of external devices which can be connected to the LAN/RJ45 port and remote/control the projector, as well as the related control commands supporting for each external device, kindly please get contact with the Support-Service team directly.

Connecting with LAN

1. Connect an RJ45 cable to RJ45 ports on the projector and the PC (Laptop).

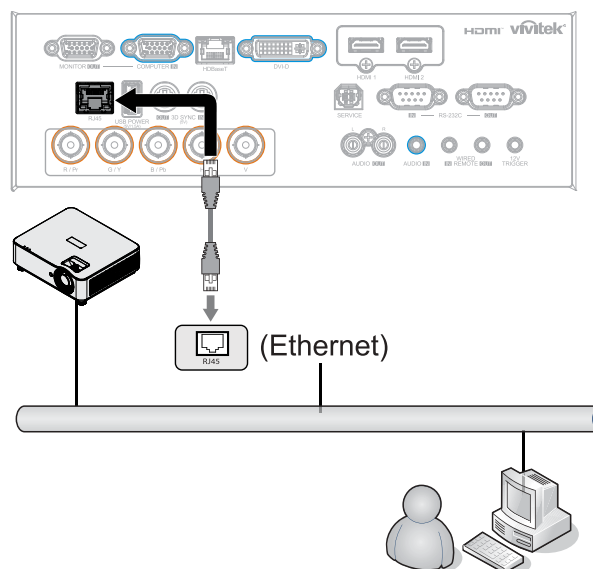

2. On the PC (Laptop), select Start → Control Panel →Network and Internet.

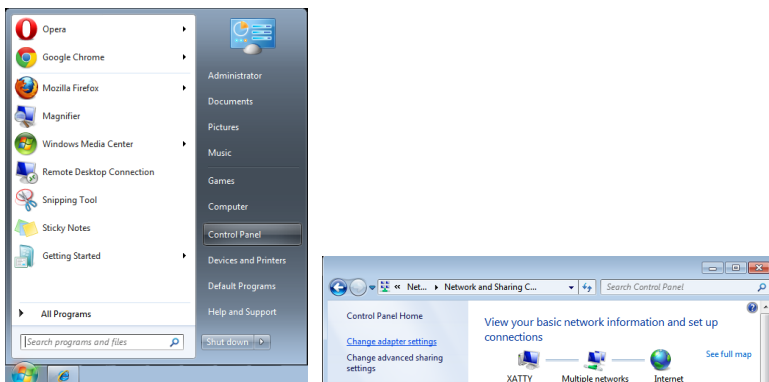

3. Right-click on Local Area Connection, and select Properties.
4. In the Properties window, select the Networking tab, and select Internet Protocol (TCP/IP).
5. Click Properties.
6. Click Use the following IP address and fill in the IP address and Subnet mask, then click OK.

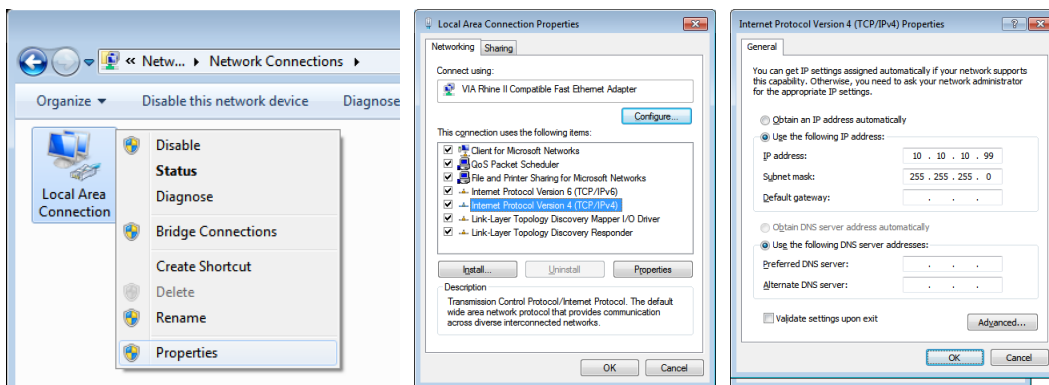

7. Press the Menu button on the projector.
8. Select CONTROL → Network
9. After getting into Network, input the following:
 - DHCP: Off
 - IP Address: 10.10.10.10
 - Subnet Mask: 255.255.255.0
 - Gateway: 0.0.0.0
 - DNS Server: 0.0.0.0

10. Press (Enter) / ► to confirm settings.

Open a web browser

(for example, Microsoft Internet Explorer with Adobe Flash Player 9.0 or higher).

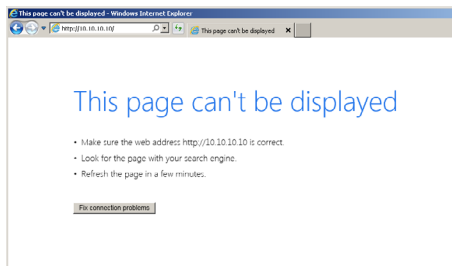

11. In the Address bar, input the IP address: 10.10.10.10.
12. Press (Enter) / ►.

The projector is setup for remote management. The LAN/RJ45 function displays as follows.

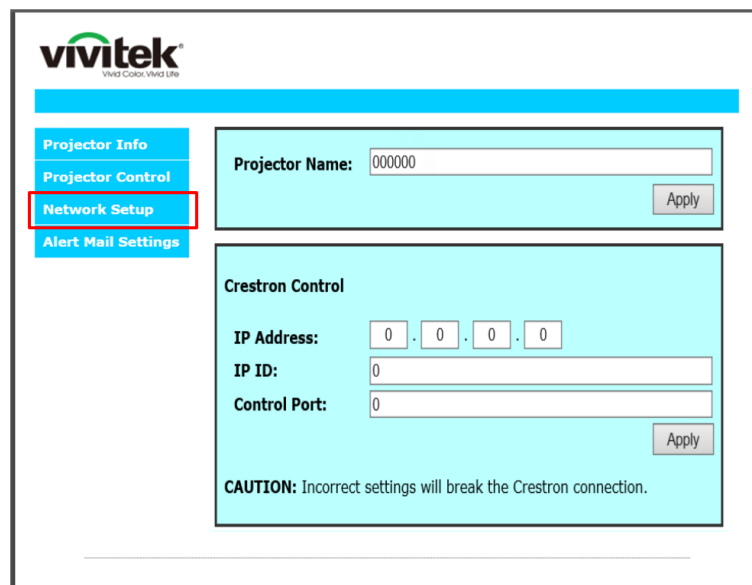
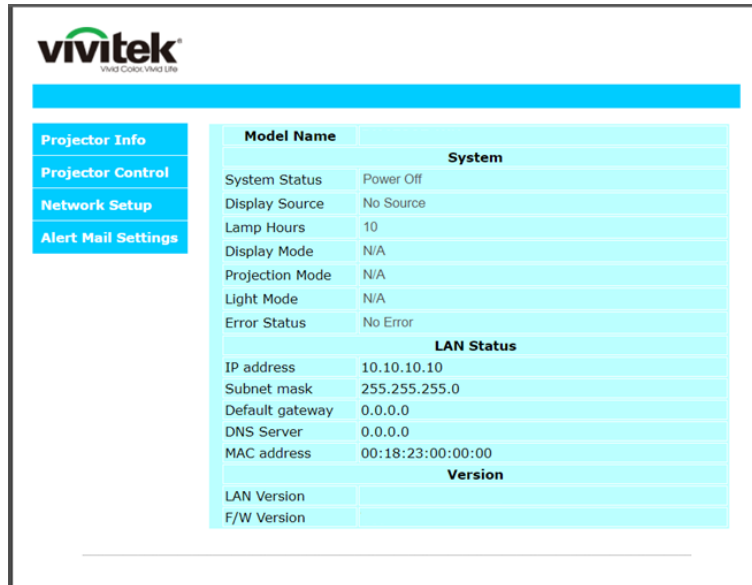

CATEGORY	ITEM	INPUT-LENGTH
Crestron Control	IP Address	15
	IP ID	3
	Port	5
Projector	Projector Name	10

For more information, please visit <http://www.crestron.com>.

Preparing Email Alerts

1. Make sure that user can access the homepage of LAN RJ45 function by web browser (for ex-ample, Microsoft Internet Explorer v6.01/v8.0).
2. From the Homepage of LAN/RJ45, click Alert Mail Settings.
3. By default, these input boxes in Alert Mail Settings are blank.

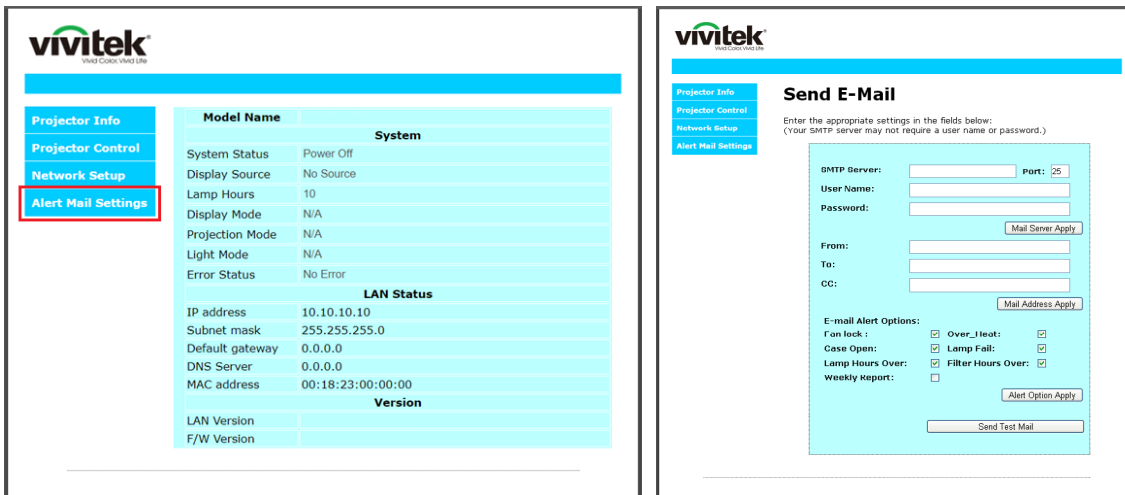

4. For Sending alert mail, input the following:
 - The SMTP field is the mail server for sending out email (SMTP protocol). This is a required field.
 - The To field is the recipient’s email address (for example, the projector administrator). This is a required field.
 - The Cc field sends a carbon copy of the alert to the specified email address. This is an optional field (for example, the projector administrator’s assistant).
 - The From field is the sender’s email address (for example, the projector administrator). This is a required field.
 - Select the alert conditions by checking the desired boxes.



Note: Fill in all fields as specified. User can click Send Test Mail to test what setting is correct. For successful sending an e-mail alert, you must select alert conditions and enter a correct e-mail address.

RS232 by Telnet Function

Besides projector connected to RS232 interface with “Hyper-Terminal” communication by dedicated RS232 command control, there is alternative RS232 command control way, so called “RS232 by TELNET” for LAN/RJ45 interface.

Quick Start-Guide for “RS232 by TELNET”

Check and get the IP-Address on OSD of the projector.

Make sure that laptop/PC can access the web-page of the projector.

Make sure that “Windows Firewall” setting to be disabled in case of “TELNET” function filtering out by laptop/PC.

Start ⇒ All Programs ⇒ Accessories ⇒ Command Prompt

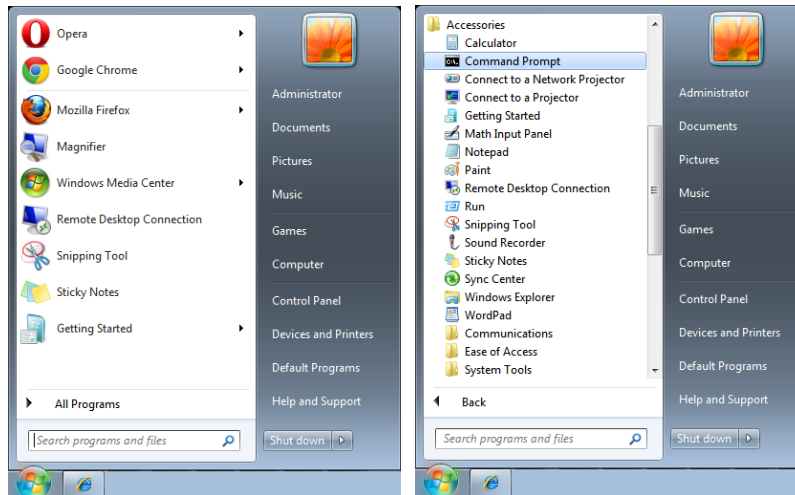

Input the command format like the below:

telnet ttt.xxx.yyy.zzz 7000 (“Enter” key pressed)

(ttt.xxx.yyy.zzz: IP-Address of the projector)

If Telnet-Connection ready, and user can have RS232 command input, then “Enter” key pressed, the RS232 command will be workable.

How to have TELNET enabled in Windows

By default installation for Windows, “TELNET” function is not included. But end-user can have it by way of “Turn Windows features On or Off” to be enabled.

Open “Control Panel” in Windows

Open “Programs”

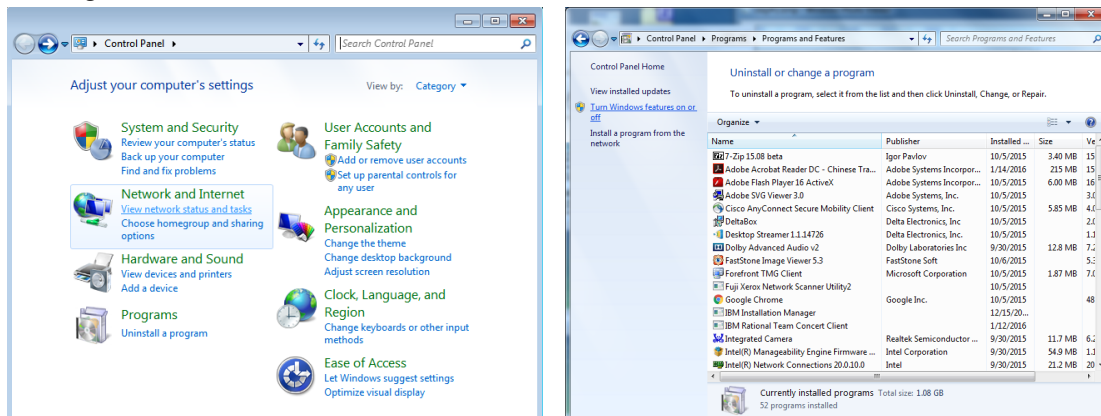

Select “Turn Windows features on or off” to open
 Have “Telnet Client” option checked, then press “OK” button.

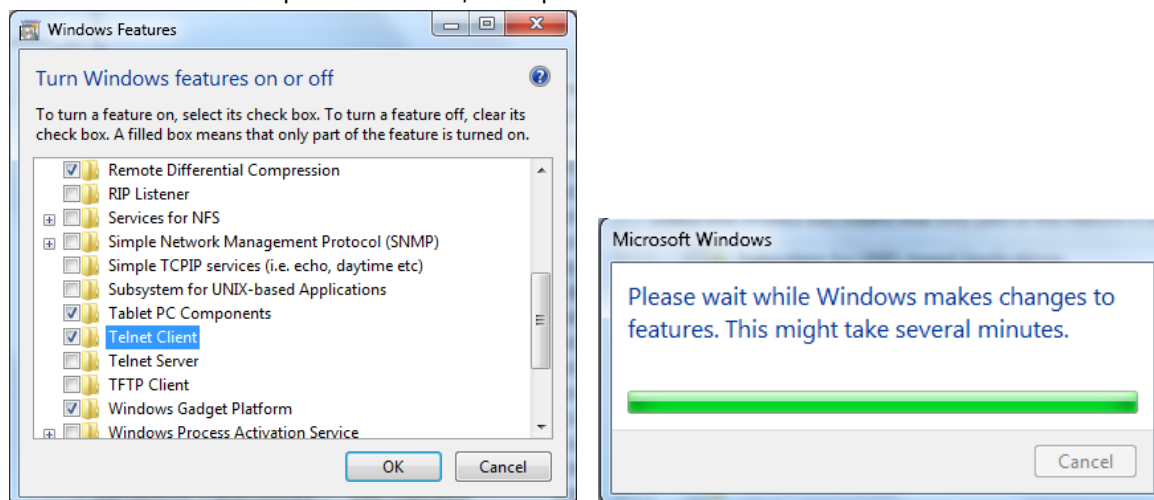

Specsheet for “RS232 by TELNET” :

1. Telnet: TCP
2. Telnet port: 7000
(for more detail, kindly please get contact with the service agent or team)
3. Telnet utility: Windows “TELNET.exe” (console mode)
4. Disconnection for RS232-by-Telnet control normally: Close Windows Telnet utility directly after TELNET connection ready
5. Limitation 1 for Telnet-Control: there is less than 50 bytes for successive network payload for Telnet-Control application.
 Limitation 2 for Telnet-Control: there is less than 26 bytes for one complete RS232 command for Telnet-Control.
 Limitation 3 for Telnet-Control: Minimum delay for next RS232 command must be more than 200 (ms).
 (*, In Windows built-in “TELNET.exe” utility, “Enter” key pressed will have “Carriage-Return” and “New-Line” code.)

Art-Net Setup

- Press ← and use ▼/▲ to scroll through submenus
- **Art-Net Enable:** Use ◀/▶ to select Art-Net
 Off: Disable Art-Net.
 On (2.X.X.X) and On (10.X.X.X): IP will be calculated automatically.
 On (Manual): Setting IP address manually.
- **Net:** Use ◀/▶ to select Net groups.
- **Sub Net:** Use ◀/▶ to select Sub-Net for each Net.
- **Universe:** Use ◀/▶ to select universes for each Sub net.
- **Start Address:** Use ◀/▶ to select Address starting point.
- **Apply:** Use ◀/▶ to select OK or Cancel after finish ArtNet settings.

- **Art-Net Channel Settings:** Use ◀/▶ to set function mapping for each channel of Art-Net. The Channel Setting definition is used to control projector with Art-Net. Please refer below table:

Channel	Channel Function	Performance	Channel Parameter	Default Value	Operation Content
1	Power	Standby	0 ~ 63	128	Light on/off projector
		No Operation	64 ~ 191		
		Power On	192 ~ 255		
2	PIC-MUTE	Shutter Open	0 ~ 63	128	Enable / Disable AV Mute
		No Operation	64 ~ 191		
		Shutter Closed	192 ~ 255		
3	Power Level	30%	0 ~ 115	255	Adjust brightness level of projector
		31%	116 ~ 117		
			
		99%	252 ~ 253		
		100%	254 ~ 255		
4	Input	No Operation	0 ~ 31	0	Change input source
		HDMI 1	32 ~ 47		
		HDMI 2	48 ~ 63		
		VGA	64 ~ 79		
		BNC (Component)	80 ~ 95		
		DisplayPort	96 ~ 111		
		No operation	112 ~ 127		
		HDBaseT	128 ~ 143		
		3G-SD	144 ~ 159		
		DVI	160 ~ 175		
No operation	178 ~ 255				
5	Channel Control(*)	Channel control is disabled	0 ~ 63	0	Enable / Disable channel operation
		No Operation	64 ~ 191		
		Channel control is enabled	192 ~ 255		

(*): Not accepted for all other channels operation when set for “Disable”.

Rental Mode

- Press ◀ and use ▼/▲ to scroll through submenus and enter 5 digits password.
- **Power Locked Level:** Press ◀ and use ▼/▲ to scroll through submenus.
 Power Locked Level: To select fixed power level output (60~100).
 Power Locked Level Reset: To reset power level output to default.
- **Usage Locked Time:** Press ◀ and use ▼/▲ to scroll through submenus.
 Usage Locked Time: To select Disable / Enable usage locked time.
 Usage Time Setting (HRS): Set the usage time. There will jump out a caution window when time run out.
 Expiration Time Reset: To restart and countdown the expiration time.
- **Change Password:** Press ◀ to change the password of Rental Mode.

Note:

If want to enable Rental Mode, please contact local agent to obtain 5 digits password.

SETTINGS Menu

Eco	Standby Power: Normal, ECO, On By Lan, (On By HDBaseT)
	No Signal Power Off (min.): 0~30~180
	Sleep Timer (min.): 0~600
Audio	Volume: 0~5~10
	Internal Speaker: Off, On
	Mute: Off, On
Air Filter	Air Filter Hours (Read Only)
	Time Reminder: Off, 300hrs., 500hrs., 1000hrs., 1500hrs., 2000hrs.
	Reset Timer: Reset Timer (execute)
Blank Screen Color	Logo, Black, Red, Green, Blue, White
Menu	Logo: Std., Black, Blue
	Message: Off, On
	Menu Position: Center, Up, Down, Left, Right
	Menu Timer: Off, 20 sec., 40 sec., 60 sec.
	Menu Translucent: Off, 50%, 100%
Keypad Lock	Off, On
Security Lock	Off, On
Language	English, Français, Deutsch, Español, Português, 简体中文, 繁體中文, Italiano, Norsk, Svenska, Nederlands, Русский, Polski, Suomi, Ελληνικά, 한국어, Magyar, Čeština, Türkçe, 日本語, Dansk

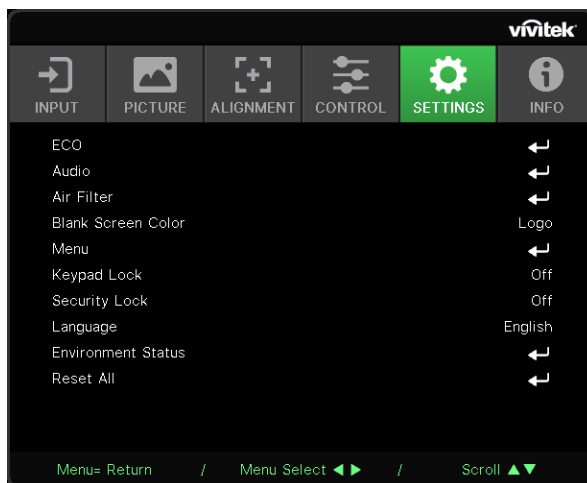

Environment Status	execute
Reset All	OK, Cancel

Eco

- Press and use / to scroll through submenus.
- **Standby Power:** Use / to switch Normal / Eco / On by LAN / On By HDBaseT (Only shown and gray out when HDBaseT-IR_RS232_RJ45 set "On").
- **No Signal Power Off (mins):** Use / to increase or decrease time lapse before automatic Power Off mode to count down under no signal before turning off projector automatically.
- **Sleep Timer (mins):** Use / to increase or decrease time lapse before automatic sleep mode.

Audio

- Press and use / to scroll through submenus.
- **Volume:** Use / to increase or decrease the projector sound volume.
- **Internal Speaker:** Use / to switch On/Off the built in Internal Speaker of projector.
- **Mute:** Use / to switch On/Off the built in Speaker of projector.

Air Filter

- Press and use / to scroll through submenus.
- **Air Filter Hours:** Display accumulated hours usage of Air Filter.
- **Time Reminder:** Use / to switch On/Off of the Air Filter Timer.
- **Reset Timer:** Press to reset air filter timer.

Blank Screen Color

- Use / to select screen background color (Logo, Black, Red, Green, Blue, White).

Menu

- Press and use / to scroll through submenus.
- **Logo:** Use / to select the Logo (Std., Black, Blue).
- **Message:** Use / to switch On/Off.
- **Menu Position:** Use / to select the menu position (Center,Up,Down,Left,Right).
- **Menu Timer:** Use / to switch time : Off / 20sec. / 40sec. / 60sec. to pop off Menu.
- **Menu Translucent:** Use / to switch Off / 50% /100% for Menu transparency.

Keypad Lock

- Use / to to switch On/Off for Keypad lock.

Note :

To unlock by keypad, please press " " for 5 sec and then pop-out "keypad unlock".

Security Lock

- Use ◀/▶ to switch On/Off for Security Lock.

Password

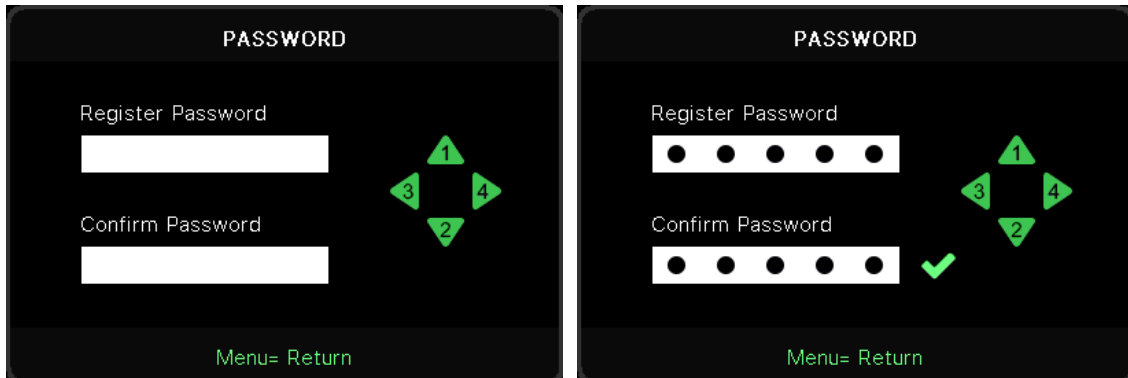

- When Security Lock is on, show popup "password input".
- Press ▲/▼/◀/▶ to set the password, total 5 digits.

Note:

Every time will show "password check" to key in when startup. If wrong over 5 times ,please contact with local service center.

Language

- Press and use ▼/▲ to scroll through submenus.
- Press ↵ to enter the languages submenus.
- Press ▲/▼/◀/▶ button to scroll and highlight your language.
- Press the MENU button to exit the language submenus.

Environment Status

- Press ↵ to display the Environment Status sub menu.

Environment Status					
T1	25	Fan1	1100	Fan11	1100
T2	25	Fan2	1100	Fan12	1100
T3	25	Fan3	1100	Fan13	1100
T4	25	Fan4	1100	Fan14	1100
T5	25	Fan5	1100	Fan15	1100
T6	25	Fan6	1100		
T7	25	Fan7	1100		
T8	25	Fan8	1100		
T9	25	Fan9	1100		
T10	25	Fan10	1100		
T State	1st				

Menu= Exit

Reset All

- Press  to select the reset all will show popup "reset all confirm" to check.

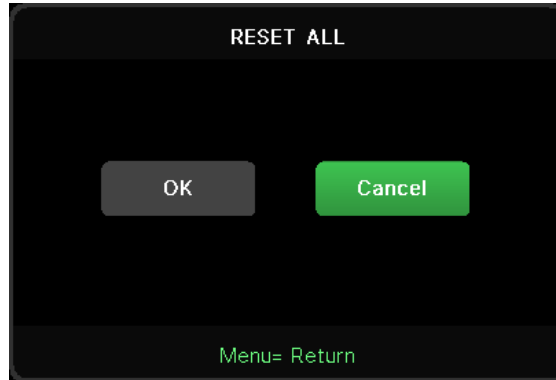

Note:

Depending on the video source, not all items in the OSD are available. For example, the Horizontal/Vertical Position items in the Computer menu can only be modified when connected to a PC. Items that are not available cannot be accessed and are grayed out.

INFO Screen

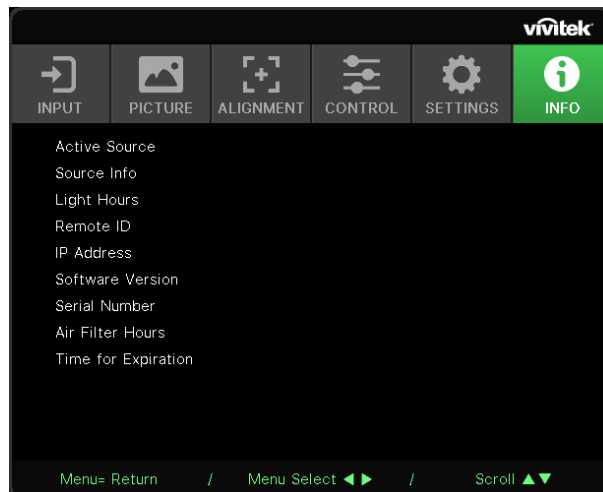

This screen displays the projector current status information to be used for technical support.

4.Troubleshooting

Common Problems and Solutions

These guidelines provide tips to deal with problems you may encounter while using the projector. If the problem remains unsolved, contact your dealer for assistance.

Often after time spent troubleshooting, the problem is traced to something as simple as a loose connection.

Check the following before proceeding to the problem-specific solutions.

- Use some other electrical device to confirm that the electrical outlet is working.
- Ensure the projector is turned on.
- Ensure all connections are securely attached.
- Ensure the attached device is turned on.
- Ensure a connected PC is not in suspending mode.
- Ensure a connected notebook computer is configured for an external display.

(This is usually done by pressing an Fn-key combination on the notebook.)

Troubleshooting Tips

In each problem-specific section, try the steps in the order suggested. This may help you to solve the problem more quickly.

Try to pin point the problem and thus avoid replacing non-defective parts.

For example, if you replace batteries and the problem remains, put the original batteries back and go to the next step.

Keep a record of the steps you take when troubleshooting: The information may be useful when calling for technical support or for passing on to service personnel.

LED Indicator Messages

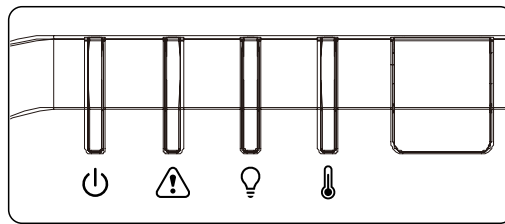

LED Code Messages	Power LED (Green)	Status LED (Red)	Light LED (Red)	Temp LED (Red)
Light Ready	ON	OFF	OFF	OFF
Start	Flashing	OFF	OFF	OFF
Cooling	Flashing	OFF	OFF	OFF
1W MCU detects scaler stops working	2 blinks	OFF	OFF	OFF
Over Temperature T1 / Sensor T1 lost connect	OFF	OFF	1 blinks	ON
Over Temperature T2 / Sensor T2 lost connect	OFF	OFF	2 blinks	ON
Over Temperature T3 / Sensor T3 lost connect	OFF	OFF	3 blinks	ON
Over Temperature T4 / Sensor T4 lost connect	OFF	OFF	4 blinks	ON
Over Temperature T5 / Sensor T5 lost connect	OFF	OFF	5 blinks	ON
Over Temperature T6 / Sensor T6 lost connect	OFF	OFF	6 blinks	ON
Over Temperature T7 / Sensor T7 lost connect	OFF	OFF	7 blinks	ON
Over Temperature T8 / Sensor T8 lost connect	OFF	OFF	8 blinks	ON
Thermal Break Sensor error	OFF	4 blinks	OFF	OFF
Laser Light Source error	OFF	4 blinks	1 blinks	OFF
FAN1 error	OFF	6 blinks	1 blinks	OFF
FAN2 error	OFF	6 blinks	2 blinks	OFF
FAN3 error	OFF	6 blinks	3 blinks	OFF
FAN4 error	OFF	6 blinks	4 blinks	OFF
FAN5 error	OFF	6 blinks	5 blinks	OFF
FAN6 error	OFF	6 blinks	6 blinks	OFF
FAN7 error	OFF	6 blinks	7 blinks	OFF
FAN8 error	OFF	6 blinks	8 blinks	OFF
FAN9 error	OFF	6 blinks	9 blinks	OFF
FAN10 error	OFF	6 blinks	10 blinks	OFF
Case Open	OFF	7 blinks	OFF	OFF
Lens Open	OFF	7 blinks	1 blinks	OFF
DMD error	OFF	8 blinks	OFF	OFF
Color wheel error	OFF	9 blinks	OFF	OFF
Phosphor wheel error	OFF	9 blinks	1 blinks	OFF

Note:

In the event of an error, please disconnect the AC power cord and wait for one (1) minute before restarting the projector. If the Power or Light source LEDs are still blinking or the Over Temp LED is lit, contact your service center.

Image Problems Q&A

Q. NO image appears on the screen

- Verify the settings on your notebook or desktop PC.
- Turn off all equipment and power up again in the correct order.

Q. The image is blurred

- Adjust the Focus on the projector.
- Ensure the projector-to-screen distance is within the specified range.
- Check that the projector lens is clean.

Q. The image is reversed

- Check the Projection setting on the ALIGNMENT menu of the OSD.

Q. The image is streaked

- Set the Phase and Clock settings on the Input → Analog menu of the OSD to the default settings.
- To ensure the problem is not caused by a connected PC's video card, connect to another computer.

Q. The image is flat with no contrast

- Adjust the Contrast setting on the PICTURE menu of the OSD.

Q. The colour of the projected image does not match the source image.

- Adjust the Color Temperature and Gamma settings on the PICTURE > Advanced menu of the OSD.

Light Source Problems

Q. There is no light from the projector

- Check that the power cable is securely connected.
- Ensure the power source is good by testing with another electrical device.
- Restart the projector in the correct order and check that the Power LED is on.

Remote Control Problems

Q. The projector does not respond to the remote control

- Direct the remote control towards remote sensor on the projector.
- Ensure the path between remote and sensor is not obstructed.
- Turn off any fluorescent lights in the room.
- Check the battery polarity.
- Replace the batteries.
- Turn off other Infrared-enabled devices in the vicinity.
- Have the remote control serviced.

Audio Problems

Q. There is no sound

- Adjust the volume on the remote control.
- Adjust the volume of the audio source.
- Check the audio cable connection.
- Test the source audio output with other speakers.
- Have the projector serviced.

Q. The sound is distorted

- Check the audio cable connection.
- Test the source audio output with other speakers.
- Have the projector serviced.

Having the Projector Serviced

If you are unable to solve the problem, you should have the projector serviced. Pack the projector in the original carton. Include a description of the problem and a checklist of the steps you took when trying to fix the problem: The information may be useful to service personnel. For servicing, return the projector to the place you purchased it.

HDMI Q&A

Q. What is the difference between a “Standard” HDMI cable and a “High-Speed” HDMI cable?

Recently, HDMI Licensing, LLC announced that cables would be tested as Standard or High-Speed cables.

Standard (or “category 1”) HDMI cables have been tested to perform at speeds of 75Mhz or up to 2.25Gbps, which is the equivalent of a 720p/1080i signal.

High Speed (or “category 2”) HDMI cables have been tested to perform at speeds of 340Mhz or up to 10.2Gbps, which is the highest bandwidth currently available over an HDMI cable and can successfully handle 1080p signals including those at increased color depths and/or increased refresh rates from the Source. High-Speed cables are also able to accommodate higher resolution displays, such as WQXGA cinema monitors (resolution of 2560 x 1600).

Q. How do I run HDMI cables longer than 10 meters?

There are many HDMI Adopters working on HDMI solutions that extend a cable’s effective distance from the typical 10 meter range to much longer lengths. These companies manufacture a variety of solutions that include active cables (active electronics built into cables that boost and extend the cable’s signal), repeaters, amplifiers as well as CAT5/6 and fiber solutions.

Q. How can I tell if a cable is an HDMI certified cable?

All HDMI products are required to be certified by the manufacturer as part of the HDMI Compliance Test Specification. However, there may be instances where cables bearing the HDMI logo are available but have not been properly tested. HDMI Licensing, LLC actively investigates these instances to ensure that the HDMI trademark is properly used in the market. We recommend that consumers buy their cables from a reputable source and a company that is trusted.

5. Specifications

Projector Dimensions

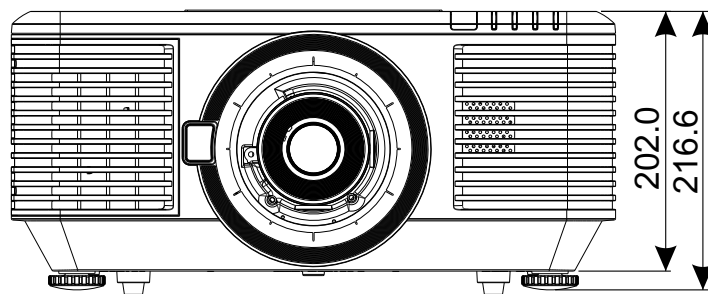
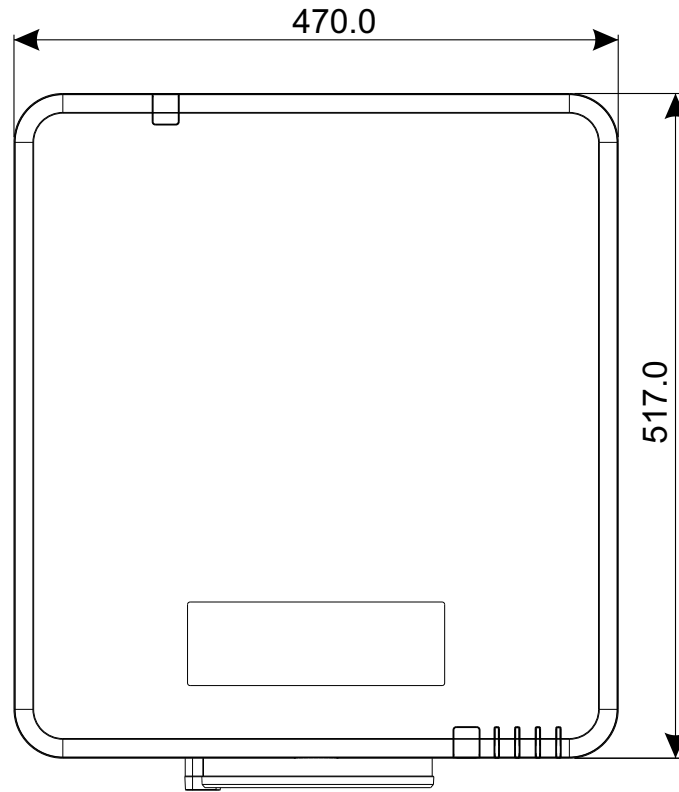

Projector DataSheet

Model Name	DU7099Z	DU7199Z	DU7299Z
Display Type	0.67 WUXGA , 1 DLP		
Brightness	7600 lumens	8600 lumens	9600 lumens
Native Resolution	WUXGA (1,920 x 1,200)		
Maximum Resolution	4K(3840×2160)@60Hz		
Contrast Ratio	1,300:1 (Native) / 20,000:1 (Dynamic) / 3,000,000:1 (Full On/Off)		
Laser Life/Type	Up to 20,000 hours (Laser Phosphor)		
Throw Ratio(*)	1.54 - 1.93		
Image Size (Diagonal) (*)	48.2" - 300"		
Projection Distance(*)	2m - 10m (6.56ft – 32.8ft)		
Projection Lens(*)	F#2.02~2.4 , f= 22.84~28.61mm		
Zoom Ratio(*)	1.25X Manual Zoom, Manual Focus		
Aspect Ratio	16:10		
Keystone Correction	Vertical/Horizontal ±30°		
Horizontal Frequency	15 or 31 - 91.4kHz		
Vertical Frequency	24 - 30Hz, 47 - 120Hz		
3D Compatibility	Yes (DLP® Link™, HDMI v2.0 Blu-ray, side by side, frame packing, top and bottom)		
Speaker	Peak 10W *2		
Lens Shift	Vertical: -50% to +70%, Horizontal: -15% to +15%		
Computer Compatibility	VGA, SVGA, XGA, SXGA, SXGA+, UXGA, WUXGA, 4K@60hz, Mac		
I/O Connection Ports	HDMI v2 (x2) (HDCP v2.2 Compliant), DVI-D, Component (5 BNC) (RGBHV), 3D-Sync-In, VGA-In , Audio-In (Mini-Jack), Monitor-Out, Audio-Out RCA (L/R), 3D Sync-Out, USB Type A Power (5V/1.5A),12V Trigger, RS-232-In, RS-232-Out, Wired Remote-In, Wired Remote-Out, HDBaseT™, RJ45 (LAN)(10/100Mbps), USB (Service)		
Projection Method	Table Top, Ceiling Mount, Portrait (Front or Rear)		
Security Solutions	Kensington® Security Slot, Security Bar, Keypad Lock		
Dimensions (WxDxH)	470 x 517 x 202mm (18.5" x 20.35" x 7.95")(without ADJ-foot)		
Weight	20.6kg (45.5lbs)	23.5Kg (63.0lbs)	
Available Colors	Black or White		
Noise Level	34dB/32dB (Normal/ Eco. Mode)	37dB/34dB (Normal/ Eco. Mode)	40dB/38dB (Normal/ Eco. Mode)
Power Supply	AC 100-240V, 50/60Hz		
Power Consumption	465W (Normal)	540W (Normal)	575W (Normal)
	<0.5W (Standby), <2W (on by Lan)		
Environmental Operation Condition	At temperature 0 to 40°C, relative humidity 10% to 85%, non-condensation		
Environmental Storage Condition	At temperature -10 to 60°C, relative humidity 5% to 95%,non-condensation		

Note:

"*" : Standard lens.

Projector Time Table

Signal	Resolu- tion	H-SYNC (KHz)	V-SYNC (Hz)	Com- posite S_Video	Com- pon- ent	VGA/BNC (Analog)	DVI	HDMI	HDBaseT
							(DIGITAL)		
NTSC	–	15.734	60	O(3D:S)	–	–	–		
PAL/ SECAM	–	15.625	50	O	–	–	–		
VESA	720 x 400	31.5	70.1	–	–	O	O		
	640 x 480	31.5	60	–	–	O(3D:FS,TB,SBS)	O(3D:FS,TB,SBS)		
	640 x 480	35	66.667	–	–	MAC13	MAC13		
	640 x 480	37.86	72.8	–	–	-	O		
	640 x 480	37.5	75	–	–	O	O		
	640 x 480	43.3	85	–	–	O	O		
	640 x 480	61.9	119.5	–	–	O	O		
	800 x 600	37.9	60.3	–	–	O(3D:FS,TB,SBS)	O(3D:FS,TB,SBS)		
	800 x 600	46.9	75	–	–	O	O		
	800 x 600	48.1	72.2	–	–	O	O		
	800 x 600	53.7	85.1	–	–	O	O		
	800 x 600	76.3	120	–	–	O(3D:FS)	O(3D:FS)		
	832 x 624	49.722	74.546	–	–	MAC16	MAC16		
	1024 x 768	48.4	60	–	–	O(3D:FS,TB,SBS)	O(3D:FS,TB,SBS)		
	1024 x 768	56.5	70.1	–	–	O	O		
	1024 x 768	60.241	75.02	–	–	MAC19	MAC19		
	1024 x 768	60	75	–	–	O	O		
	1024 x 768	68.7	85	–	–	O	O		
	1024 x 768	97.6	120	–	–	O(3D:FS)	O(3D:FS)		
	1152 x 870	68.68	75.06	–	–	MAC21	MAC21		
	1280 x 720	45	60	–	–	OO(3D:FS, TB,SBS)	O(3D:FS,TB,SBS)		
	1280 x 720	90	120	–	–	O(3D:FS)	O(3D:FS)	O	
	1280 x 768 (Reduce Blanking)	47.4	60	–	–	OO(3D:FS, TB,SBS)	O(3D:FS,TB,SBS)		
	1280 x 768	47.8	59.9	–	–	OO(3D:FS, TB,SBS)	O(3D:FS,TB,SBS)		
	1280 x 800	49.7	59.8	–	–	OO(3D:FS, TB,SBS)	O(3D:FS,TB,SBS)		
	1280 x 800	62.8	74.9	–	–	O	O		
	1280 x 800	71.6	84.9	–	–	O	O		
	1280 x 800	101.6	119.9	–	–	O(3D:FS)	O(3D:FS)		
1280 x 1024	64	60	–	–	O (3D:TB,SBS)	O(3D:TB,SBS)			
1280 x 1024	80	75	–	–	O	O			
1280 x 1024	91.1	85	–	–	O	O			
1280 x 960	60	60	–	–	O (3D:TB,SBS)	O(3D:TB,SBS)			
1280 x 960	85.9	85	–	–	O	O			

Signal	Resolution	H-SYNC (KHz)	V-SYNC (Hz)	Com- posite S_Video	Com- pon- ent	VGA/BNC (Analog)	DVI	HDMI	HDBaseT
							(DIGITAL)		
VESA	1400 x 1050	65.3	60	–	–	○ (3D:TB,SBS)	○(3D:TB,SBS)		
	1440 x 900	55.9	59.9	–	–	○(3D:TB,SBS)	○(3D:TB,SBS)		
	1600 x1200	75	60	–	–	○(3D:TB,SBS)	○ (3D:TB ,SBS)	○(3D:TB)	
	1680 x1050 (Reduce Blanking)	64.67	59.88	–	–	○(3D:TB,SBS)	○(3D:TB,SBS)		
	1680 x1050	65.29	59.95	–	–	○(3D:TB,SBS)	○(3D:TB,SBS)		
	1920 x 1080	67.5	60	–	–	○(3D:TB,FS,SBS)	○(3D:TB,FS,SBS)		
	1920 x 1200 (Reduce Blanking)	74.038	59.95	–	–	○(3D:TB,FS,SBS)	○(3D:TB,FS,SBS)		
	1280 x 1024	130	120 (Reduce Blanking)	–	–	–	–	○	–
	1400 x 1050	93.9	85	–	–	–	–	○	–
	1440 x 900	114.2	120 (Reduce Blanking)	–	–	–	–	○	–
	1600 x 1200	87.5	70	–	–	–	–	○	–
	1600 x 1200	93.8	75	–	–	–	–	○	–
	1600 x 1200	106.3	85	–	–	–	–	○	–
	1600 x 1200	152.4	120 (Reduce Blanking)	–	–	–	–	○	–
	1680 x 1050	82.3	75	–	–	–	–	○	–
	1680 x 1050	93.9	85	–	–	–	–	○	–
	1680 x 1050	133.4	120 (Reduce Blanking)	–	–	–	–	○	–
	1920 x 1200	74.6	60	–	–	–	–	○(3D:TB ,FS,SBS)	–
	1920 x 1200	94	75	–	–	–	–	○	–
	1920 x 1200	107.2	85	–	–	–	–	○	–
	3840 x 2160	53,946	23.976	–	–	–	–	○	
	3840 x 2160	54	24	–	–	–	–	○	
	3840 x 2160	56.25	25	–	–	–	–	○	
3840 x 2160	67.5	30	–	–	–	–	○		
3840 x 2160	112.5	50	–	–	–	–	○		
3840 x 2160	135	60	–	–	–	–	○		

Signal	Resolu- tion	H-SYNC (KHz)	V-SYNC (Hz)	Com- posite S_Video	Com- ponent	VGA/BNC (Analog)	DVI	HDMI	HDBaseT
							(DIGITAL)		
SDTV	480i	15.734	60	–	○	–	–	(3D:FS)	
	576i	15.625	50	–	○	–	–		
EDTV	576p	31.3	50	–	○	–	–		
	480p	31.5	60	–	○	–	–	(3D:FS)	
HDTV	720p	37.5	50	–	○	–	–	(3D:FP,TB,SBS)	
	720p	45	60	–	○	–	–	(3D:FP,TB,FS,SBS)	
	1080i	33.8	60	–	○	–	–		
	1080i	28.1	50	–	○	–	–	(3D:SBS)	
	1080p	27	24	–	○	–	–		
	1080p	28	25	–	○	–	–		
	1080p	33.7	30	–	○	–	–		
	1080p	56.3	50	–	○	–	–	(3D:TB,SBS)	
	1080p	67.5	60	–	○	–	–	(3D:TB,SBS)	

○ : Supported frequency

– : Not Supported frequency

FS ⇒ Field Sequential

TB ⇒ Top / Bottom

SBS ⇒ Side-By-Side

FP ⇒ Frame Packing

The native resolution of the panel is 1920 x 1200. Resolution other than native resolution may be display with uneven size of text or line.

SDTV \ EDTV \ HDTV may have a little noise is acceptable.

6. Regulatory Compliance

FCC Warning

This equipment has been tested and found to comply with the limits for a Class A digital device pursuant to Part 15 of the FCC Rules. These limits are designed to provide reasonable protection against harmful interference when the equipment is operated in a commercial environment.

This equipment generates, uses, and can radiate radio frequency energy and, if not installed and used in accordance with the instruction manual, may cause harmful interference to radio communications. Operation of this equipment in a residential area is likely to cause harmful interference in which case the user will be required to correct the interference at his/her own expense.

Changes or modifications not expressly approved by the parties responsible for compliance could void the user's authority to operate the equipment.

Canada

This class B digital apparatus complies with Canadian ICES-003.

Safety Certifications

FCC Class A, CE, C-tick, CCC, KC/KCC, CU, CB, BIS, RoHS, PSB, ICES-003 (Canada), cTUVus, BSMI and China CECP

Disposal and Recycling

This product may contain other electronic waste that can be hazardous if not disposed of properly. Recycle or dispose in accordance with local, state, or federal Laws. For more information, contact the Electronic Industries Alliance at www.eiae.org.

7. RS-232 Communication

Communication parameter setup

You can use the serial control command to input commands for projector control or retrieve its operational data through Windows client terminal software

Item	Parameter:
Bit per Second	9600 bps
Data Bit	8-bit
Parity	None
Stop Bit	1
Flow Control	None

Operation commands

Operation command syntax

An operation command is prefixed by character "op", followed by control commands and settings separated by space blank [SP], and ended by carriage return pair "CR" and "ASCII hex 0D". Syntax of serial control commands:

op[SP]<operation command>[SP]<Setting Value>[CR]

op A constant indicating this is an operation command.

[SP] Indicate one blank space.

[CR] Indicate the command ending carriage return pair "CR" and "ASCII hex 0D".

Setting value Settings of operation command

Types of setup strings	Characters of settings	Description
Query current setup	?	Question mark "?" indicates querying current setup
Setup	= <settings>	Syntax: Symbol "=" suffixed with setup values
Increase setup order of adjustment items	+	Some settings are changed in steps. Symbol "+" indicates changing one step up
Decrease setup order of adjustment items	-	Some settings are changed in steps. Symbol "-" indicates changing one step down
Execute operation command	None	Certain operation commands execute after input without further setting or regulators.

Examples:		
Control items	Input command row	Projector return message
Query current brightness	op bright ?[CR]	OP BRIGHT = 50
Set up brightness	op bright = 100[CR]	OP BRIGHT = 100
Out of range or not support	op bright = 200[CR]	OP BRIGHT = NA
Illegal command	op abright = 100[CR]	*Illegal format#

Function	Operation	Set	Get	Inc	Dec	EXE	Values
Auto Source	auto.src	V	V				0 = Off 1 = On
HDMI Color Space	color.space	V	V				0 : Auto 1 : RGB 2 : YUV
HDMI Range	hdmi.range	V	V				0 : Auto 1 : Full 2 : Limited
HDMI Format	hdmi.format	V	V				0 : Auto 1 : RGB Limited 2 : RGB Full 3 : YUV Limited 4 : YUV Full
Video AGC	video.agc	V	V				0 : Off 1 : On
Video Saturation	video.saturation	V	V	V	V		0 ~ 100
Video Tint	video.tint	V	V	V	V		0 ~ 100
Closed Caption	cc	V	V				0 : Off 1 : On
H Position	h.pos	V	V	V	V		-5 ~ +5 -100 ~ +100(Auto Sync Off)
V Position	v.pos	V	V	V	V		-5 ~ +5 -100 ~ +100(Auto Sync Off)
Phase	phase	V	V	V	V		0 ~ 31
clock	clock	V	V	V	V		-5 ~ +5
Auto Sync	auto.sync	V	V				0 : Off 1 : On
HDBaseT Control	hdbaset	V	V				0 : Off 1 : On
HDBaseT Connect	hdbaset.connect		V				0 : Disconnect 1 : Connected
3D	threed	V	V				0 : DLP-Link 1 : IR
3D Sync Invert	threed.syncinvert	V	V				0 = Off 1 = On
3D Format	threed.format	V	V				0 : Auto 1 : Top / Bottom 2 : Frame Sequential 3 : Frame Packing 4 : Side by side 5 : Off
3D Sync Out Delay	threed.syncdelay	V	V				0 ~ 359
3D Sync Input	threed.syncinput		V				0 : Internal 1 : External
3D Sync Output	threed.syncoutput	V	V				0 : Internal 1 : External

Function	Operation	Set	Get	Inc	Dec	EXE	Values
Picture Mode	pic.mode	V	V				0:Presentation 1:Bright 2:Game 3:Movie 4: Vivid 5: Blending 6: sRGB 7:DICOM SIM 8:User 9: 3D 10: HDR 10
Brightness	bright	V	V	V	V		0 ~ 100
Contrast	contrast	V	V	V	V		0 ~ 100
HDR Control	hdr.control	V	V				0 : Auto 1 : Off 2 : HDR 10
HDR Mode	hdr.mode	V	V				0 : PQ-L300 1 : PQ-L400 2 : PQ-L500 3 : PQ-L600 4 : PQ-L700
Dynamic Black	dblack	V	V				0 = Off 1 = On
"Projector Light (Light Off Timer)"	projector.light	V	V				0 : Disable 1: 1 Sec 2: 2 Sec 3: 3 Sec 4: 4 Sec
HSG/Red Gain	hsg.r.gain	V	V	V	V		5 ~ 195
HSG/Green Gain	hsg.g.gain	V	V	V	V		5 ~ 195
HSG/Blue Gain	hsg.b.gain	V	V	V	V		5 ~ 195
HSG/Cyan Gain	hsg.c.gain	V	V	V	V		5 ~ 195
HSG/Magenta Gain	hsg.m.gain	V	V	V	V		5 ~ 195
HSG/Yellow Gain	hsg.y.gain	V	V	V	V		5 ~ 195
HSG/Red/Saturation	hsg.r.sat	V	V	V	V		0 ~ 199
HSG/Green/Saturation	hsg.g.sat	V	V	V	V		0 ~ 199
HSG/Blue/Saturation	hsg.b.sat	V	V	V	V		0 ~ 199
HSG/Cyan/Saturation	hsg.c.sat	V	V	V	V		0 ~ 199
HSG/Magenta/Saturation	hsg.m.sat	V	V	V	V		0 ~ 199
HSG/Yellow/Saturation	hsg.y.sat	V	V	V	V		0 ~ 199
HSG/Red/Hue	hsg.r.hue	V	V	V	V		-99 ~ 99
HSG/Green/Hue	hsg.g.hue	V	V	V	V		-99 ~ 99
HSG/Blue/Hue	hsg.b. hue	V	V	V	V		-99 ~ 99
HSG/Cyan/Hue	hsg.c. hue	V	V	V	V		-99 ~ 99
HSG/Magenta/Hue	hsg.m. hue	V	V	V	V		-99 ~ 99
HSG/Yellow/Hue	hsg.y. hue	V	V	V	V		-99 ~ 99
HSG/White/Red Gain	hsg.wr.gain	V	V	V	V		0 ~ 399
HSG/White/Green Gain	hsg.wg.gain	V	V	V	V		0 ~ 399
HSG/White/Blue Gain	hsg.wb.gain	V	V	V	V		0 ~ 399
Brilliant Color	bri.color	V	V	V	V		0 ~ 10
Sharpness	sharp	V	V	V	V		0 ~ 31
Gamma	gamma	V	V				0 = 1.8 1 = 2.0 2 = 2.2 3 = 2.4 4 = B&W 5 = Linear

Function	Operation	Set	Get	Inc	Dec	EXE	Values
Color Temperature	color.temp	V	V				0 = Warm 1 = Normal 2 = Cold
Input Balance /Red Offset	red.offset	V	V	V	V		-100 ~ +100
Input Balance /Green Offset	green.offset	V	V	V	V		-100 ~ +100
Input Balance /Blue Offset	blue.offset	V	V	V	V		-100 ~ +100
Input Balance /Red Gain	red.gain	V	V	V	V		0 ~ 200
Input Balance /Green Gain	green.gain	V	V	V	V		0 ~ 200
Input Balance /Blue Gain	blue.gain	V	V	V	V		0 ~ 200
Picture Mode Reset	pic.mode.reset	V					0 = Current 1 = All
Aspect Ratio	aspect	V	V				0 = Fill 1 = 4:3 2 = 16:9 3 = LetterBox 4 = 2.35:1 5 = 16:10 6 = Auto
Digital Zoom	digi.zoom.in	V	V	V	V		0 ~ +10
	digi.zoom.out	V	V	V	V		-40 ~ 0
H Image Shift	img.hshift	V	V	V	V		-50 ~ +50
V Image Shift	img.vshift	V	V	V	V		-50 ~ +50
V Keystone	v.keystone	V	V	V	V		-30 ~ +30
H Keystone	h.keystone	V	V	V	V		-30 ~ +30
Auto Keystone	auto.keystone	V	V				0 = Off 1 = On
4 Corner Top Left X	4corner.tlx	V	V	V	V		0 ~ +60
4 Corner Top Left Y	4corner.tly	V	V	V	V		0 ~ +60
4 Corner Top Right X	4corner.trx	V	V	V	V		0 ~ +60
4 Corner Top Right Y	4corner.try	V	V	V	V		0 ~ +60
4 Corner Bottom Left X	4corner.blx	V	V	V	V		0 ~ +60
4 Corner Bottom Left Y	4corner.bly	V	V	V	V		0 ~ +60
4 Corner Bottom Right X	4corner.brx	V	V	V	V		0 ~ +60
4 Corner Bottom Right y	4corner.bry	V	V	V	V		0 ~ +60
4 Corner Reset	4corner.reset					V	
Mask Top	mask.top	V	V	V	V		0 ~ 100
Mask Bottom	mask.bottom	V	V	V	V		0 ~ 100
Mask Left	mask.left	V	V	V	V		0 ~ 100
Mask Right	mask.right	V	V	V	V		0 ~ 100
Projection	projection	V	V				0 = Front 1 = Rear 2 = Ceiling 3 = Rear + Ceiling
Screen Format	screen.format	V	V				0 : 16:10 1 : 16:9 2 : 4:3 3: 2.35:1
Screen Position	screen.shift	V	V	V	V		16:10 : Not Available 16:9 : -60 ~ 60 4:3 : -160 ~ 160 2.35:1 : -191 ~ 191
Alignment Reset	align.reset					V	

Function	Operation	Set	Get	Inc	Dec	EXE	Values
Test Pattern	test.pattern	V	V				0 = Grid 1 = White 2 = Red 3 = Green 4 = Blue 5 = Black 6 = RGB Ramps 7 = Color Bar 8 = Setp Bar 9 = CheckBoard 10 = Horizontal Lines 11 = Vertical Lines 12 = Diagnoal Lines 13 = Horizontal Ramps 14 = Vertical Ramps 15 = Off
Direct Power On	direct.poweron	V	V				0 : Off 1 : On
Signal Power On VGA	signal.poweron.vga	V	V				0 : Off 1 : On
Signal Power On HDMI	signal.poweron.hdmi	V	V				0 : Off 1 : On
Light Mode	light.mode	V	V				0: Normal 1: ECO 2: Custom Light
Custom Light	custom.light	V	V	V	V		25 ~ 100
Fan Speed	fanspeed	V	V				0 = Normal 1 = High
IR Control	ir.control	V	V				0 : Front + Rear IR On 1 : Front IR On 2 : Rear IR On 3 : Front + Rear IR Off
Remote ID	remote.id	V	V				0 ~ 99
HDMI1 EDID	edid.mode.hdmi1	V	V				0 : Enhanced 1 : Standard
HDMI2 EDID	edid.mode.hdmi2	V	V				0 : Enhanced 1 : Standard
HDBaseT EDID	edid.mode.hdbt	V	V				0 : Enhanced 1 : Standard
NetWork Status	net.status		V				0 : Disconnect 1 : Connected
NetWork / DHCP	net.dhcp	V	V				0 = Off 1 = On
NetWork / IP Address	net.ipaddr	V	V				<string>
NetWork / Subnet	net.subnet	V	V				<string>
NetWork / Gateway	net.gateway	V	V				<string>
NetWork / DNS	net.dns	V	V				<string>
NetWork Apply	net.apply	V					0 : Cancel 1 : OK
Standby Power	standby.power	V	V				0: Normal 1: ECO 2: On By Lan 3: On By HDBaseT
No Signal Power Off	nosignal.poweroff	V	V				0 ~ 36
Sleep Timer	sleep.timer	V	V				0 ~ 120
Volume	volume	V	V	V	V		0 ~ 10
Mic Volume	mic.volume	V	V	V	V		0 ~ 10

Function	Operation	Set	Get	Inc	Dec	EXE	Values
Mic	mic	V	V				0 : Off 1 : On
Air Filter Hours	airfilter.hours		V				<string>
Air Filter Time Reminder	airfilter.reminder	V	V				0 : Off (default) 1 : 300 Hrs 2 : 500 Hrs 3 : 1000 Hrs 4 : 1500 Hrs 5 : 2000 Hrs
Air Filter Reset Timer	airfilter.reset					V	
Rental Mode Password Reset	rental.pwd.reset					V	
Constant Brightness	laser.cbc.enable	V	V				0 : Off 1 : On
Blank Screen Color	blankscreen.color	V	V				0 = Logo 1 = Black 2 = Red 3 = Green 4 = Blue 5 = White
Logo	logo	V	V				0 = Std. 1 = Black 2 = Blue
Message	message	V	V				0 : Off 1 : On
MENU Position	menu.position	V	V				0 : Center 1 : Up 2 : Down 3 : Left 4 : Right
MENU Timer	menu.timer	V	V				0 : Off 1 : 20 sec. 2 : 40 sec. 3 : 60 sec.
MENU Translucent	menu.trans	V	V				0 : Off 1 : 50% 2 : 100%
Keypad Lock	keypad.lock	V	V				0 : Off 1 : On
Security Lock	security.lock	V	V				1 : Up 2 : Down 3 : Left 4 : Right
Security Unlock	security.unlock	V					1 : Up 2 : Down 3 : Left 4 : Right

Function	Operation	Set	Get	Inc	Dec	EXE	Values
Language	lang	V	V				0 = English 1 = French 2 = German 3 = Spanish 4 = Portugues 5 = Simplified Chinese 6 = Traditional Chinese 7 = Italian 8 = Norwegian 9 = Swedish 10 = Dutch 11 = Russian 12 = Polish 13 = Finnish 14 = Greek 15 = Korean 16 = Hungarian 17 = Czech 18 = Turkish 19 = Japanese 20 = Danish
Reset All	reset.all					V	
Source Info	source.info		V				<string>
Light Hours 1	light1.hours		V				<string>
Light Hours 1 Reset	light1.reset					V	
Remote Code	remote.code		V				<string>
Software Version	sw.ver		V				<string>
Serial Number	ser.no		V				<string>
Auto Image	auto.img					V	
Light 1 Status	light1.stat		V				0 = Off 1 = On
Model	model		V				<string>
Pixel Clock	pixel.clock		V				<string>
H Refresh Rate	h.refresh		V				<string>
V Refresh Rate	v.refresh		V				<string>
Blank	blank	V	V				0 = Off 1 = On
Power On	power.on					V	
Power Off	power.off					V	
Projector Status	status		V				0 : Reset 1 : Standby 2 : Active 3 : Cooling 4 : Warmup 5 : Powerup 6 : Failure
Mute	mute	V	V				0 : Off 1 : On
Freeze	freeze	V	V				0 : Off 1 : On
Internal Speaker	speaker	V	V				0 : Off 1 : On

Function	Operation	Set	Get	Inc	Dec	EXE	Values
Input Select	input.sel	V	V				1 :VGA 2: RGB2 3: DVI 4: Video 5: S-Video 6: HDMI 1 7: BNC 8: Component 9: HDMI 2 15: HDBaseT
Art-Net Enable	artnet.enable	V	V				0 = Off 1 = On (2.X.X.X) 2 = On (10.X.X.X) 3 = On (Manual)
Art-Net Net	artnet.net	V	V				0 ~ 127
Art-Net SubNet	artnet.subnet	V	V				0 ~ 15
Art-Net Universe	artnet.universe	V	V				0 ~ 15
Art-Net Start Address	artnet.start.addr	V	V				1 ~ 508
Art-Net Apply	artnet.apply	V	V				0 : Cancel 1 : OK
Art-Net Channel 1 Function	artnet.ch1.func	V	V				0 = None 1 = Power 2 = PIC-MUTE 3 = Power Level 4 = Input 5 = Channel Control
Art-Net Channel 2 Function	artnet.ch2.func	V	V				0 = None 1 = Power 2 = PIC-MUTE 3 = Power Level 4 = Input 5 = Channel Control
Art-Net Channel 3 Function	artnet.ch3.func	V	V				0 = None 1 = Power 2 = PIC-MUTE 3 = Power Level 4 = Input 5 = Channel Control
Art-Net Channel 4 Function	artnet.ch4.func	V	V				0 = None 1 = Power 2 = PIC-MUTE 3 = Power Level 4 = Input 5 = Channel Control
Art-Net Channel 5 Function	artnet.ch5.func	V	V				0 = None 1 = Power 2 = PIC-MUTE 3 = Power Level 4 = Input 5 = Channel Control

Lens related function

Function	Operation	Set	Get	Inc	Dec	EXE	Values
Lens Lock	lens.lock	V	V				0: off 1:on
Lens zoom in	zoom.in					V	
Lens zoom in 2	zoom.in.2					V	
Lens zoom in 3	zoom.in.3					V	
Lens zoom out	zoom.out					V	
Lens zoom out 2	zoom.out.2					V	
Lens zoom out 3	zoom.out.3					V	
Lens focus near	focus.near					V	
Lens focus near 2	focus.near.2					V	
Lens focus near 3	focus.near.3					V	
Lens focus far	focus.far					V	
Lens focus far 2	focus.far.2					V	
Lens focus far 3	focus.far.3					V	
Lens up	lens.up					V	
Lens up 2	lens.up.2					V	
Lens up 3	lens.up.3					V	
Lens down	lens.down					V	
Lens down 2	lens.down.2					V	
Lens down 3	lens.down.3					V	
Lens left	lens.left					V	
Lens left 2	lens.left.2					V	
Lens left 3	lens.left.3					V	
Lens right	lens.right					V	
Lens right 2	lens.right.2					V	
Lens right 3	lens.right.3					V	
Lens center	lens.center					V	
Lens type	lens.type	V	V				0 : Non-UST Lens 1 : UST Lens
Lens load	lens.load	V					1~8
Lens save	lens.save	V					1~8
Lens clear	lens.clear	V					1~8

8. Services

Europe, Middle East and Africa

Vivitek Service & Support
Zandsteen 15
2132 MZ Hoofddorp
The Netherlands
Tel: Monday - Friday 09:00 - 18:00
English (UK): 0333 0031993
Germany: 0231 7266 9190
France: 018 514 8582
Russian: +7 (495) 276-22-11
International: +31 (0) 20 721 9318
Email: support@vivitek.eu
URL: <http://www.vivitek.eu/support/contact-support>

North America

Vivitek Service Center
15700 Don Julian Road, Suite B
City of Industry, CA. 91745
U.S.A
Tel: 855-885-2378 (Toll-Free)
Email: T.services1@vivitekcorp.com
URL: www.vivitekusa.com

Asia and Taiwan

Vivitek Service Center
7F, No.186, Ruey Kuang Road, Neihu District
Taipei, Taiwan 11491
Tel: 886-2-8797-2088, ext. 6899 (Direct)
Tel: 0800-042-100 (Toll-Free)
Email: kenny.chang@vivitek.com.tw
URL: www.vivitek.com.tw

中国/China

Vivitek客服中心
上海市闵行区申长路618号绿谷广场A座7楼
邮政编码: 201106
400客服热线: 400 888 3526
公司电话: 021-58360088
客服邮箱: service@vivitek.com.cn
官方网站: www.vivitek.com.cn



Visit www.vivitekc corp.com for more product info
Copyright (c) 2023 Delta Electronics, Inc. All Rights Reserved

A brand of  DELTA